

AIR TOOLS



Contents



Air Screwdrivers..... 138 - 147

Air Impact Wrenches 148 - 160

Power Scalers 161 - 162

Air Sanders/Air Grinders 163 - 168

Air Saws/Air Drills 169 - 172

Air Dusters 173 - 177

HAND TOOLS

BITS & SOCKETS

ELECTRIC TOOLS

AIR TOOLS

STATIC SOLUTIONS

GASOLINE ENGINE TOOLS

AIR TOOLS TECHNICAL



Environmental measures

Pb (lead), Cd (cadmium), Hg (mercury), hexavalent chromium, PBB (polybrominated biphenyl), and PBDE (polybrominated diphenyl ether)
This symbol indicates the products that conform to VESSEL's environment measure standards compliant with the restriction of the use of certain hazardous substances (six substances listed above) (RoHS directive).



HAND TOOLS

BITS & SOCKETS

ELECTRIC TOOLS

AIR TOOLS

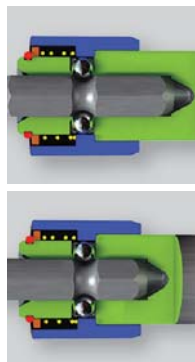

Standard A type anvil

Can be used with A type of industrial bits.
For more information, contact us.

Option

Can be used with B type of industrial bits.
For more information, contact us.



Pin-lock Type Anvil

Insert socket and lock with a pin.
Mainly used for industrial assembly line.

Retainer Ring Type Anvil

Pin type anvil combined with a retainer ring.

Tough Aluminum Body

Mechanism : Air Screwdriver

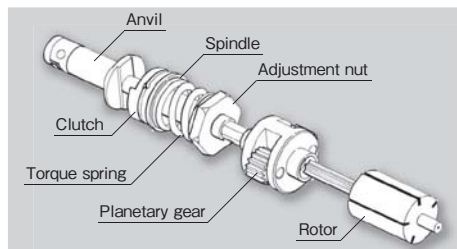

Clutch Type / Gear Type Air Screwdriver

The speed of air motor rotation is reduced by planetary gears so as to raise the rotation torque. Smooth and stable tightening can be performed via engagement of the clutch.

Torque Control Type : When the tightening torque reaches to the specified level, the air supply is cut off by the movement of cam-shaft, and operation is suspended.

142P

146P
147P

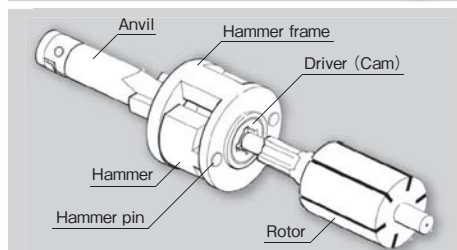

Impact type Air Screwdriver

The hammer which is rotated by the rotor makes use of the impact of the striking the anvil, and a construction is obtained which generates a powerful tightening force.

Torque Control Type : As the bolt or nut is tightened, its resistance value increases, and the percussion part and rotary part are greatly inverted. This angle of inversion is caught by the clutch, transmitted to the stop valve, and the air is cut off.

143P
~145P

147P

STATIC SOLUTIONS

GASOLINE ENGINE TOOLS



Oil Xtra Series

The impact mechanism is filled with lubricating oil. In addition to changing the impact noise to a softer, smoother sound, the oil prevents part damage due to friction.



Adjust Dial (Dual-purpose switch)

Consolidated control part combining air flow control switch and forward reverse control switch.



Adjust Dial

Exclusive adjust dial suited for work requiring frequent flow control.

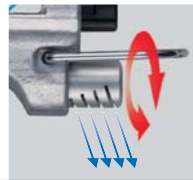

Silencer

Built-in filter reduces exhaust sound.

Mechanism : Air Impact Wrench

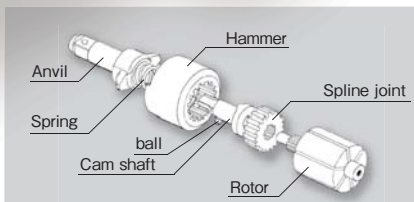

Impact Type Innovative "V" Hammer

A hammer moves forward and backward by rotating and hit the anvil, which makes powerful and speedy tightening. Good hammering efficiency, and compact and light-weight type.

150P
151P

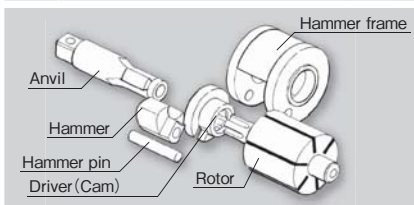

Impact Type Single Hammer

A construction whereby 1 rotation of the rotor causes the hammer to inflict 1 blow on the anvil. Due to this 1 rotation/1 percussion system, a strong tightening is obtainable.

154P
~156P

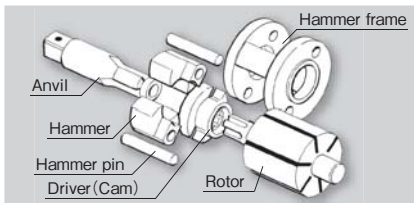

Impact Type Double Hammer

A construction whereby 1 rotation of the rotor causes the hammer to inflict 2 blows on the anvil. Due to this 1 rotation/2 percussions system, a stable tightening is obtainable.

157P
~159P

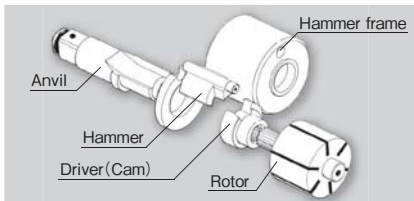

Pinless Impact Type Pinless Hammer

Rotation force of air motor is transmitted to the driver (cum) to rotate the hammer to hit the anvil, the impact of which enhances impact efficiency, allowing for firm screw tightening. Introduced pinless hammer which is small but outputs a great torque force.

152P
153P

No. GT-P5XD

Air Screwdrivers Oil Xtra Series



A wide variety of air screwdrivers for high efficiency work.

We have developed products such as "Oil Extra" series which is filled with oil in the impact part unit, as well as air tube exhaust models, aiming at reducing noise and vibration.



No. GT-P5XD

Air Screwdrivers

The impact mechanism is filled with lubricating oil. In addition to changing the impact noise to a softer, smoother sound, the oil prevents part damage due to friction.

HAND TOOLS

BITS & SOCKETS

ELECTRIC TOOLS

AIR TOOLS

STATIC SOLUTIONS

GASOLINE ENGINE TOOLS

Applicable Models ※Only for referential purposes.

Small screw	Philips	Applicable Models
M2	0 (Old JIS 1)	S4TFG, S4TG
M2.3	0 (Old JIS 1)	S4TFG, S4TFS, S4TG, S4TS
M2.5	1	S4TFG, S4TFS, S4TG, S4TS, S5TFG, S5TG
M2.6	0 (Old JIS 1)	H4RC, S4TFS, S4TS, S5TFG, S5TG
M3	1 (Old JIS 2)	H4R, H4PR, PH4, H4RC, S4TFS, S4TFR, S4TS, S4TR, S5TFG, S5TFB, S5TG, S5TB
M3.5	2	H4R, H4PR, PH4, H4RC, H5RC, S4TR, S4TFR, S5TFB, S5TB
M4	2	H4R, H4PR, PH4, H5R, H5P, PH5, H5RC, S4.5DR, P4.5DR, PLR, PLP, PLZ, PLRC, P5LS, S4TFR, S4TR, S5TFB, S5TFR, S5TB, S5TR, PLXD, S4.5XD, P4.5XD, PLIXD, P5XD
M4.5	2	H5R, H5P, PH5, H5RC, S4.5DR, P4.5DR, PLR, PLP, PLZ, PLRC, P5LS, S5TFR, S5TR, S5TS, PLXD, S4.5XD, P4.5XD, PLIXD, P5XD
M5	2	H5R, H5P, PH5, S4.5DR, P4.5DR, PLR, PLP, PLZ, PLRC, P5LS, P6LSIII, P6HS, PLHII, P60XD, S6MLR, S6HS, S6CD, S5TFR, S5TR, S5TS, PLXD, S4.5XD, P4.5XD, P6EXD, S6LXD, P6LXD, S60XD, PLIXD, P5XD
M6	3	P6LSIII, P6HS, PLHII, S6MLR, S6HS, S5TS, S6.5D, P6.5D, S6CD, P6EXD, S6LXD, P6LXD, P60XD, S60XD
M8	4 (Old JIS 3)	S6.5D, P6.5D, P8D, P10SII, P60XD, S60XD, P80XD
M10	4	P8D, P10SII, P80XD

Wood screw	Philips	Applicable Models
1.8	—	H4R, H4PR, PH4
2.1	1	H4R, H4PR, PH4
2.4	1	H4R, H4PR, PH4
2.7	1	H5R, H5P, PH5, S4.5DR, P4.5DR, PLR, PLP, PLZ, P5LS, S4.5XD, P4.5XD
3.1	2	H5R, H5P, PH5, S4.5DR, P4.5DR, PLR, PLP, PLZ, P5LS, S4.5XD, P4.5XD
3.5	2	H5R, H5P, PH5, S4.5DR, P4.5DR, PLR, PLP, PLZ, P5LS, P6LSIII, P6HS, PLHII, S6MLR, S6HS, S6CD, PLXD, S4.5XD, P4.5XD, P6EXD, S6LXD, P6LXD, P60XD, S60XD, PLIXD, P5XD
3.8	2	PLHII, P6LSIII, S6MLR, S6HS, P6HS, S6CD, S6.5D, P6.5D, PLXD, P6EXD, S6LXD, P6LXD, P60XD, S60XD, PLIXD, P5XD
4.1	2	PLHII, P6LSIII, S6MLR, S6HS, P6HS, S6CD, S6.5D, P6.5D, P6EXD, S6LXD, P6LXD, P60XD, S60XD
4.5	2	S6.5D, P6.5D, P6EXD, P60XD, P8D, P10SII, S60XD, P80XD
4.8	2	P8D, P10SII, P6EXD, P80XD
5.1	3	P8D, P10SII, P80XD
5.5	3	P8D, P10SII, P80XD
5.8	3	P8D, P10SII, P80XD
6.2	3	P8D, P10SII, P80XD

Tapping screw	Philips	Applicable Models
3.5	2	H5R, H5P, PH5, S4.5DR, P4.5DR, PLR, PLP, PLZ, P5LS, S4.5XD, P4.5XD
4	2	H5R, H5P, PH5, S4.5DR, P4.5DR, PLR, PLP, PLZ, P5LS, P6LSIII, P6HS, PLHII, S6MLR, S6HS, S6.5D, P6.5D, S6CD, PLXD, PLIXD, P5XD, S4.5XD, P4.5XD, P6EXD, S6LXD, P6LXD, P60XD, S60XD
4.2	2	P6LSIII, P6HS, PLHII, S6MLR, S6HS, S6.5D, P6.5D, S6CD, PLXD, PLIXD, P5XD, P6EXD, S6LXD, P6LXD, P60XD, S60XD
4.5	2	P6LSIII, P6HS, PLHII, S6MLR, S6HS, S6.5D, P6.5D, S6CD, P6EXD, S6LXD, P6LXD, P60XD, S60XD
4.8	2	P6.5D, P60XD, S60XD
5	2	P6.5D, P8D, P10SII, P60XD, S60XD, P80XD
5.5	3	P8D, P10SII, P80XD
6	3	P8D, P10SII, P80XD

Hexagonal recess bolt Hexagonal head bolt	H (mm)	H (mm)	Applicable Models
M2.5	2.0	5.0	H4RC
M3	2.5	5.5	H4R, H4PR, PH4, H4RC
M3.5	—	6.0	H4R, H4PR, PH4, H4RC, H5RC
M4	3.0	7.0	H4R, H4PR, PH4, H5R, H5P, PH5, H5RC, S4.5DR, P4.5DR, PLR, PLP, PLZ, P5LS, PLRC, PLXD, S4.5XD, P4.5XD, PLIXD, P5XD
M5	4.0	8.0	H5R, H5P, PH5, S4.5DR, P4.5DR, PLR, PLP, PLZ, P5LS, P6LSIII, P6HS, PLHII, S6MLR, S6HS, S6CD, PLXD, S4.5XD, P4.5XD, P6EXD, S6LXD, P6LXD, P60XD, S60XD, PLIXD, P5XD
M6	5.0	10.0	P6LSIII, P6HS, PLHII, S6MLR, S6HS, S6.5D, P6.5D, S6CD, P6EXD, S6LXD, P6LXD, P60XD, S60XD
M7	—	11.0	S6.5D, P6.5D, P60XD, S60XD
M8	6.0	13.0 (Small bolt 12.0)	S6.5D, P6.5D, P8D, P10SII, P60XD, S60XD, P80XD
M10	8.0	16.0 (Old JIS 17.0) Small bolt 14.0)	P8D, P10SII, P80XD

HAND TOOLS

BITS & SOCKETS

ELECTRIC TOOLS

AIR TOOLS

STATIC SOLUTIONS

GASOLINE ENGINE TOOLS

Standard screw **4~5mm** Compact, lightweight and high revolution motor. For recycle plant, small sash frame, etc.

Oil Xtra Series

←See P138



No. GT-S4.5XD

6.35 Bit sleeve retainer

Noise reducer



No. GT-P4.5XD

6.35 Bit sleeve retainer

Noise reducer/Rear exhaust



No. GT-PLXD

6.35 Bit sleeve retainer

3 Adjust dial

Noise reducer



No. GT-P5XD NEW

6.35 Bit sleeve retainer

Noise reducer/Rear exhaust



No. GT-PLIXD

6.35 Bit sleeve retainer

3 Adjust dial

Noise reducer

Suppress noise with air tube

See P141 One point→

Standard screw **5~6mm** Stable tightening performance with high power. For sash frame for building, exterior, home building, etc.



No. GT-S6LXD

6.35 Bit sleeve retainer

3 Adjust dial

Noise reducer

No. GT-P6LXD

6.35 Bit sleeve retainer

Noise reducer/Rear exhaust



Model No.	Capacity (mm)				No Load Speed (rpm)	Air Consumption (ml/min)	Hose Coupling	Overall Length (mm)	Weight (g)	Accessories		EDP No.
	Standard Screw	Tapping Screw	Wood Screw	Bolt						Bit	Plug	
GT-S4.5XD	4.0~5.0	3.5~4.0	2.7~3.5	4.0~5.0	14,500	0.2	G 1/4	188	585	A14 Φ 2×65G	BPN-2F	311085
GT-P4.5XD	4.0~5.0	3.5~4.0	2.7~3.5	4.0~5.0	14,000	0.2	Rc 1/4	170	735	A14 Φ 2×65G	BPB-2	311089
GT-PLXD	4.0~5.0	3.8~4.2	3.3~3.8	4.0~5.0	11,000	0.35	G 1/4	198.5	670	A14 Φ 2×65G	BPN-2F	311113
GT-P5XD	4.0~5.0	3.5~4.0	3.3~3.8	4.0~5.0	11,000	0.33	Rc 1/4	172	790	A14 Φ 2×65G	BPB-2	311100
GT-PLIXD	4.0~5.0	3.8~4.2	3.3~3.8	4.0~5.0	7,300	0.29	G 1/4	198	740	A14 Φ 2×65G	BPN-2F Tube fitting PL8-02	311114
GT-S6LXD	5.0~6.0	4.0~4.5	3.6~4.1	5.0~6.0	12,000	0.4	G 1/4	212	815	A14 Φ 2×65G	BPN-2F	311115
GT-P6LXD	5.0~6.0	4.0~4.5	3.6~4.1	5.0~6.0	12,500	0.45	Rc 1/4	184	876	A14 Φ 2×65G	BPB-2	311116

·Air pressure: 0.6MPa ·Air hose diameter: 6.35mm ·Overall length and Weight: Accessories not included.
 ·Capacity is listed as instant reference and depends on operation conditions.

·w/Rotary parts oil (VG-10), Impact parts oil (VG-32)

Bit installation anvil application

Unless otherwise mentioned, following type is a standard.

Standard type in Japan

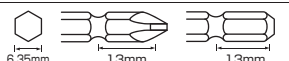

※Option: Following retainer anvil is available.

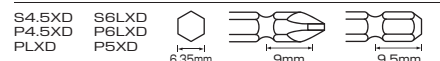

Standard screw **6~8mm** Powerful torque force. For installing parts, fastening concrete screw, etc.

Oil Xtra Series



No. GT-P60XD

6.35 Bit sleeve retainer

3 Adjust dial

Noise reducer/Rear exhaust



No. GT-S60XD

6.35 Bit sleeve retainer

3 Adjust dial

Noise reducer/Rear exhaust



Standard screw **8~10mm** Powerful torque force. For installing parts, fastening concrete screw, etc.



No. GT-P80XD

8 Bit sleeve retainer

4 Adjust dial

Noise reducer/Rear exhaust



Standard screw **5~6mm** High power models for construction.



No. GT-P6EXD

6.35 Bit sleeve retainer

3 Adjust dial

Noise reducer/Rear exhaust



Does not damage work piece with protector.

One point

Suppress noise with air tube

Exhaust noise is reduced by mounting existing $\varnothing 8$ air tube.

No. GT-PLIXD

-8dB

※No-load noise
Approx. **78dB**

Compared to the existing similar models
with 2m air tube attached.

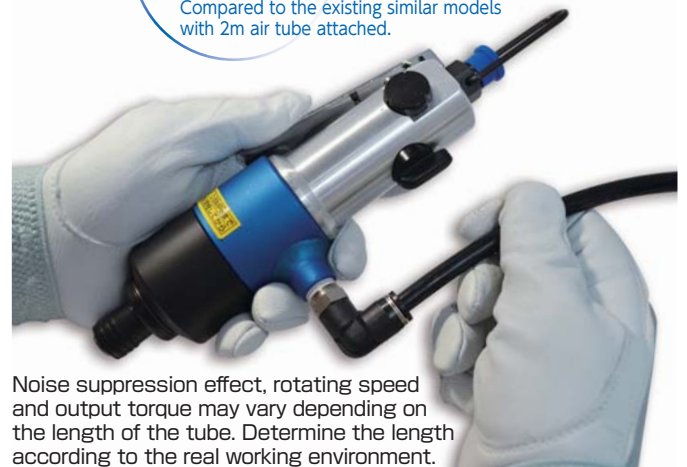

Noise suppression effect, rotating speed and output torque may vary depending on the length of the tube. Determine the length according to the real working environment.

Model No.	Capacity (mm)				No Load Speed (rpm)	Air Consumption (m ³ /min)	Hose Coupling	Overall Length (mm)	Weight (g)	Accessories			EDP No.
	Standard Screw	Tapping Screw	Wood Screw	Bolt						Bit	Plug	L-wrench	
GT-P60XD	6.0~8.0	4.0~5.0	3.8~4.5	6.0~8.0	7,500	0.38	Rc 1/4	176	1,130	A14 $\varnothing 2 \times 65E / \varnothing 3 \times 65E$	BPB-2	-	324021
GT-S60XD	6.0~8.0	4.0~5.0	3.8~4.5	6.0~8.0	7,500	0.38	Rc 1/4	198	1,030	A14 $\varnothing 2 \times 65E / \varnothing 3 \times 65E$	BPB-2	-	324023
GT-P80XD	8.0~10.0	5.0~6.0	4.5~6.2	8.0~10.0	7,000	0.4	Rc 1/4	172	1,520	A15 $\varnothing 2 \times 65G / \varnothing 3 \times 65E$	BPB-2	H4	324050
GT-P6EXD	5.0~6.0	4.0~4.5	3.6~4.8	5.0~6.0	9,300	0.55	Rc 1/4	155	1,085	A14 $\varnothing 2 \times 65G$	BPB-2	-	311150

•Air pressure: 0.6MPa •Air hose diameter: 6.35mm •Overall length and Weight: Accessories not included.
•Capacity is listed as instant reference and depends on operation conditions.

•w/Rotary parts oil (VG-10), Impact parts oil (VG-32)

Bit installation anvil application

Unless otherwise mentioned, following type is a standard.

Standard type in Japan

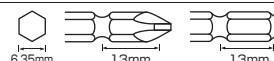

※Option: Following retainer anvil is available.

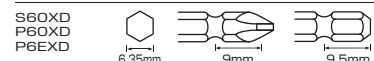

Standard screw **2.6~3.5mm** Speed-reduction type air driver.

Standard screw **3.5~4.5mm** Speed-reduction type air screwdriver.



No. GT-H4RC

6.35 Ball spring retainer
Noise reducer

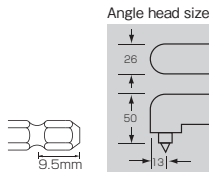

No. GT-H5RC

6.35 Ball spring retainer

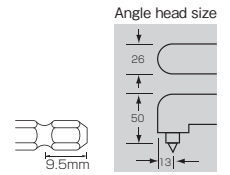

Standard screw **3~4mm** Compact, lightweight and silent gear speed-reduction mechanism.



No. GT-H4R

6.35 Ball spring retainer
Lever push starting/Noise reducer



No. GT-H4PR

6.35 Ball spring retainer
Push starting/Noise reducer

Standard screw **4~5mm** Stable tightening performance with high power. For installing electrical parts.



No. GT-H5R

6.35 Ball spring retainer
Lever push starting



No. GT-H5P

6.35 Ball spring retainer
Push starting/Noise reducer

Model No.	Capacity (mm)				No Load Speed (rpm)	Air Consumption (ml/min)	Hose Coupling	Overall Length (mm)	Weight (g)	Accessories		EDP No.
	Standard Screw	Tapping Screw	Wood Screw	Bolt						Bit	Plug	
GT-H4R	3~4	—	1.8~2.4	3~4	1,500	0.2	G 1/4	190	590	A14 Φ 2×65G	BPN-2F	311036
GT-H4PR	3~4	—	1.8~2.4	3~4	1,500	0.19	G 1/4	213	610	A14 Φ 2×65G	BPN-2F	311046
GT-H4RC	2.6~3.5	—	—	2.6~3.5	1,500	0.2	G 1/4	216	735	B39 Φ 2×23H	BPN-2F	311034
GT-H5R	4~5	3.5~4	2.7~3.5	4~5	1,500	0.25	G 1/4	225	880	A14 Φ 2×65G	BPN-2F	311066
GT-H5P	4~5	3.5~4	2.7~3.5	4~5	1,500	0.25	G 1/4	235	880	A14 Φ 2×65G	BPN-2F	311065
GT-H5RC	3.5~4.5	—	—	3.5~4.5	1,500	0.25	G 1/4	248	1,047	B39 Φ 2×23H	BPN-2F	311064

·Air pressure: 0.6MPa ·Air hose diameter: 6.35mm ·Overall length: Accessories and hanger parts not included. ·Weight: Accessories not included.
·Capacity is listed as instant reference and depends on operation conditions.

Bit installation anvil application

Unless otherwise mentioned, following type is a standard.

Standard type in Japan

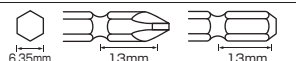

※Option: Following retainer anvil is available.

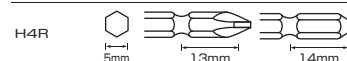

 Standard screw **4~5mm** Compact and lightweight. Basic models for assembly plant.



No. GT-S4.5DR

6.35 Bit sleeve retainer

Noise reducer



No. GT-P4.5DR

6.35 Bit sleeve retainer

Noise reducer/Rear exhaust



No. GT-PLR

6.35 Ball spring retainer

3 Adjust dial



No. GT-P5LS

6.35 Bit sleeve retainer

Noise reducer/Rear exhaust



No. GT-PLP

6.35 Ball spring retainer

Push starting/Noise reducer



No. GT-PLZ

6.35 Bit sleeve retainer

3 Adjust dial

Noise reducer



Model No.	Capacity (mm)				No Load Speed (rpm)	Air Consumption (m ³ /min)	Hose Coupling	Overall Length (mm)	Weight (g)	Accessories		EDP No.
	Standard Screw	Tapping Screw	Wood Screw	Bolt						Bit	Plug	
GT-S4.5DR	4.0~5.0	3.5~4.0	2.7~3.5	4.0~5.0	14,000	0.2	G 1/4	180	585	A14 ⊕2×65G BPN-2F		311084
GT-P4.5DR	4.0~5.0	3.5~4.0	2.7~3.5	4.0~5.0	14,000	0.2	Rc 1/4	160	715	A14 ⊕2×65G BPB-2		311088
GT-PLR	4.0~5.0	3.5~4.0	2.7~3.5	4.0~5.0	9,000	0.2	G 1/4	187	830	A14 ⊕2×65G BPN-2F		311097
GT-P5LS	4.0~5.0	3.5~4.0	2.7~3.5	4.0~5.0	9,000	0.2	Rc 1/4	165	980	A14 ⊕2×65G BPB-2	Air regulator	311099
GT-PLP	4.0~5.0	3.5~4.0	2.7~3.5	4.0~5.0	9,000	0.2	G 1/4	197	750	A14 ⊕2×65G BPN-2F		311095
GT-PLZ	4.0~5.0	3.5~4.0	2.7~3.5	4.0~5.0	9,000	0.2	G 1/4	205	950	A14 ⊕2×65G BPN-2F		311111

*Air pressure: 0.6MPa *Air hose diameter: 6.35mm *Overall length: Accessories and hanger parts not included. *Weight: Accessories not included.
 *Capacity is listed as instant reference and depends on operation conditions.

Bit installation anvil application

Unless otherwise mentioned, following type is a standard.

Standard type in Japan

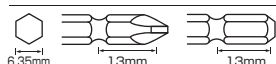

*Option: Following retainer anvil is available.



Standard screw **5~6mm** Compact and lightweight. Basic models for assembly plant.

HAND TOOLS

BITS & SOCKETS

ELECTRIC TOOLS

AIR TOOLS

STATIC SOLUTIONS

GASOLINE ENGINE TOOLS



No. GT-PLHII

6.35 Bit sleeve retainer (Pull type)

3 Adjust dial

OP Anvil (Bit sleeve retainer, push type)



No. GT-P6LSIII

6.35 Bit sleeve retainer (Pull type)

Noise reducer/Rear exhaust

OP

Anvil (Bit sleeve retainer, push type)
Rubber grip



Rubber grip type available as option.



No. GT-S6HS

6.35 Bit sleeve retainer

3 Adjust dial



No. GT-P6HS

6.35 Bit sleeve retainer

Noise reducer/Rear exhaust



No. GT-S6MLR

6.35 Bit sleeve retainer (Pull type)

3 Adjust dial



Model No.	Capacity (mm)				No Load Speed (rpm)	Air Consumption (ml/min)	Hose Coupling	Overall Length (mm)	Weight (g)	Accessories		EDP No.
	Standard Screw	Tapping Screw	Wood Screw	Bolt						Bit	Plug	
GT-PLHII	5.0~6.0	4.0~4.5	3.6~4.1	5.0~6.0	8,500	0.3	Rc 1/4	213	925	A14 Φ 2×65G	BPB-2	311094
GT-P6LSIII	5.0~6.0	4.0~4.5	3.6~4.1	5.0~6.0	9,000	0.3	Rc 1/4	177	955	A14 Φ 2×65G	BPB-2	311098
GT-S6HS	5.0~6.0	4.0~4.5	3.6~4.1	5.0~6.0	10,000	0.3	G 1/4	220	1,100	A14 Φ 2×65G	BPN-2F	311107
GT-P6HS	5.0~6.0	4.0~4.5	3.6~4.1	5.0~6.0	10,000	0.3	Rc 1/4	180	1,170	A14 Φ 2×65G	BPB-2	Air regulator 311131
GT-S6MLR	5.0~6.0	4.0~4.5	3.6~4.1	5.0~6.0	8,500	0.25	G 1/4	215	1,120	A14 Φ 2×65G	BPN-2F	311106

*Air pressure: 0.6MPa ·Air hose diameter: 6.35mm ·Overall length: Accessories and hanger parts not included. ·Weight: Accessories not included.
·Capacity is listed as instant reference and depends on operation conditions.

Bit installation anvil application

Unless otherwise mentioned, following type is a standard.

Standard type in Japan

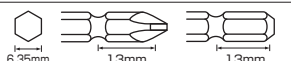

※Option: Following retainer anvil is available.

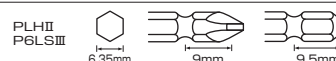

Standard screw **4~5mm** Angle impact screwdriver.



No. GT-PLRC

6.35 Ball spring retainer

3 Adjust dial

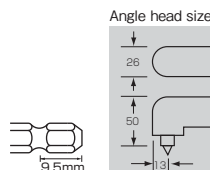

Standard screw **6~8mm** Powerful torque force. Excellent durability.



No. GT-S6.5D

6.35 Bit sleeve retainer

4 Adjust dial

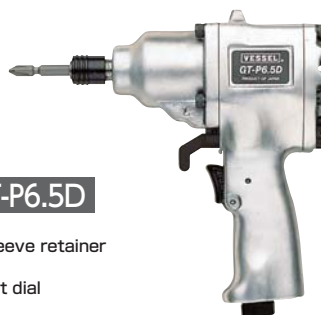

No. GT-P6.5D

6.35 Bit sleeve retainer

3 Adjust dial

Standard screw **8~10mm** High power models. For installing various parts.



No. GT-P8D

8 Bit sleeve retainer

3 Adjust dial

Model No.	Capacity (mm)				No Load Speed (rpm)	Air Consumption (m³/min)	Hose Coupling	Overall Length (mm)	Weight (g)	Accessories			EDP No.
	Standard Screw	Tapping Screw	Wood Screw	Bolt						Bit	Plug	L-wrench	
GT-PLRC	4.0~5.0	—	—	4.0~5.0	9,000	0.2	G 1/4	228	1,100	B39 Φ 2×23H	BPN-2F	—	311112
GT-S6.5D	6.0~8.0	4.0~4.5	3.8~4.5	6.0~8.0	7,500	0.35	Rc 1/4	217	1,300	A14 Φ 2×65E/ Φ 3×65E	BPB-2	H4	324040
GT-P6.5D	6.0~8.0	4.0~5.0	3.8~4.5	6.0~8.0	8,500	0.38	Rc 1/4	152	1,450	A14 Φ 2×65E/ Φ 3×65E	BPB-2	H4	324041
GT-P8D	8.0~10.0	5.0~6.0	4.5~6.2	8.0~10.0	7,500	0.4	Rc 1/4	172	1,930	A15 Φ 2×65G/ Φ 3×65E	BPB-2	H4	324046

*Air pressure: 0.6MPa *Air hose diameter: 6.35mm *Overall length and Weight: Accessories and hanger parts not included.
 *Capacity is listed as instant reference and depends on operation conditions.

Bit installation anvil application

Unless otherwise mentioned, following type is a standard.

Standard type in Japan



Torque Control Air Screwdriver, Reduced Type

Standard screw **2~2.5mm** Air is automatically shut out when torque reaches a set value.



No. GT-S4TFG

5 Ball spring retainer

Push startup type/Noise reducer/Rear exhaust
 Torque Spring

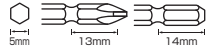

No. GT-S4TG

6.35 Ball spring retainer

Adjust dial type Push startup type/Noise reducer/Rear exhaust
 Torque Spring Hose Coupling(1/8")

Standard screw **2.2~3mm** Air is automatically shut out when torque reaches a set value.



No. GT-S4TFS

5 Ball spring retainer

Push startup type/Noise reducer/Rear exhaust
 Torque Spring

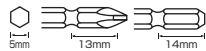

No. GT-S4TS

6.35 Ball spring retainer

Adjust dial type Push startup type/Noise reducer/Rear exhaust
 Torque Spring Hose Coupling(1/8")

Standard screw **3~4mm** Air is automatically shut out when torque reaches a set value.



No. GT-S4TFR

5 Ball spring retainer

Push startup type/Noise reducer/Rear exhaust
 Torque Spring

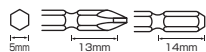

No. GT-S4TR

6.35 Ball spring retainer

Adjust dial type Push startup type/Noise reducer/Rear exhaust
 Torque Spring Hose Coupling(1/8")

Model No.	Capacity Standard Screw (mm)	Torque Range (N·m)	No Load Speed (rpm)	Air Consumption (ml/min)	Hose Coupling	Overall Length (mm)	Weight (g)	Accessories		EDP No.
								Bit	Plug	
GT-S4TFG	2.0~2.5	0.3~0.8	2,300	0.28	Rc 1/8	215	565	B36 Φ 2×70H	—	311206
GT-S4TFS	2.2~3.0	0.5~1.3	1,700	0.28	Rc 1/8	215	555	B36 Φ 2×70H	—	311205
GT-S4TFR	3.0~4.0	0.7~2.1	1,100	0.28	Rc 1/8	215	565	B36 Φ 2×70H	—	311204
GT-S4TG	2.0~2.5	0.3~0.8	2,300	0.28	Rc 1/4	215	650	A14 Φ 2×65G	BPB-2	311203
GT-S4TS	2.2~3.0	0.5~1.3	1,700	0.28	Rc 1/4	215	640	A14 Φ 2×65G	BPB-2	311202
GT-S4TR	3.0~4.0	0.7~2.1	1,100	0.28	Rc 1/4	215	650	A14 Φ 2×65G	BPB-2	311201

·Air pressure: 0.6MPa ·Air hose diameter: 6.35mm ·Overall length: Accessories and hanger parts not included. ·Weight: Accessories not included.
 ·Capacity is listed as instant reference and depends on operation condition.

One point

Torque Spring Change

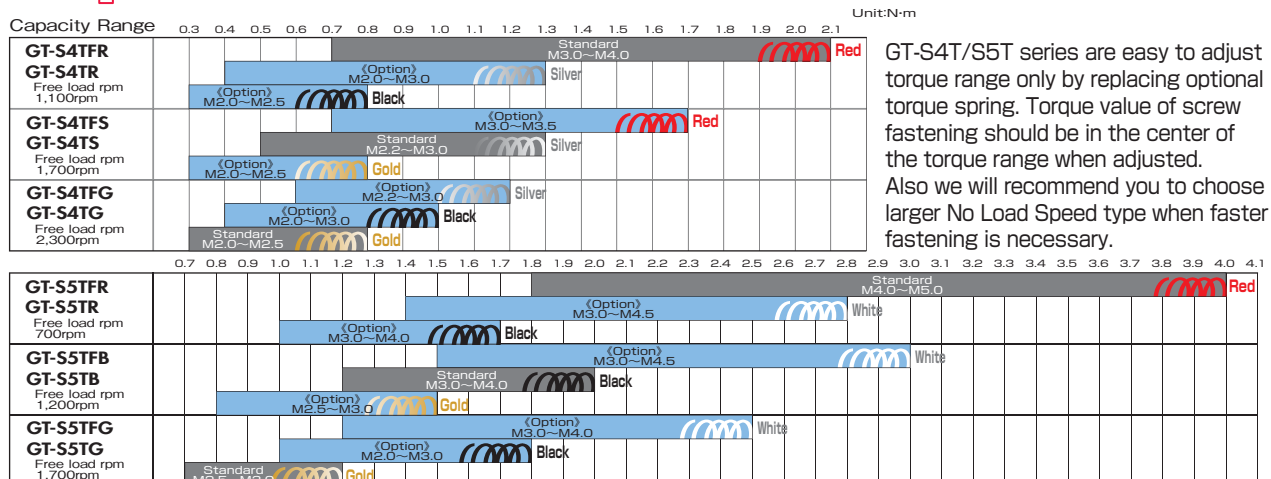

GT-S4T/S5T series are easy to adjust torque range only by replacing optional torque spring. Torque value of screw fastening should be in the center of the torque range when adjusted. Also we will recommend you to choose larger No Load Speed type when faster fastening is necessary.

Standard screw **2.5~3mm** Air is automatically shut out when torque reaches a set value.



No. GT-S5TFG

5 Ball spring retainer

Push startup type/Noise reducer/Rear exhaust
 OP Torque Spring

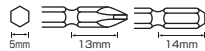

No. GT-S5TG

6.35 Ball spring retainer

Adjust dial type Push startup type/Noise reducer/Rear exhaust
 OP Torque Spring

Standard screw **3~4mm** Air is automatically shut out when torque reaches a set value.



No. GT-S5TFB

5 Ball spring retainer

Push startup type/Noise reducer/Rear exhaust
 OP Torque Spring

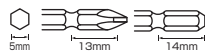

No. GT-S5TB

6.35 Ball spring retainer

Adjust dial type Push startup type/Noise reducer/Rear exhaust
 OP Torque Spring

Standard screw **4~5mm** Air is automatically shut out when torque reaches a set value.



No. GT-S5TFR

5 Ball spring retainer

Push startup type/Noise reducer/Rear exhaust
 OP Torque Spring

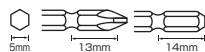

No. GT-S5TR

6.35 Ball spring retainer

Adjust dial type Push startup type/Noise reducer/Rear exhaust
 OP Torque Spring

Torque Control Air Screwdriver, Impact Type

Standard screw **4.5~6mm** Combination between impact and torque control systems gives an excellent workability.

No. GT-S5TS

6.35 Bit sleeve retainer (Pull type)

Adjust dial type



Model No.	Capacity Standard Screw (mm)	Torque Range (N·m)	No Load Speed (rpm)	Air Consumption (m ³ /min)	Hose Coupling	Overall Length (mm)	Weight (g)	Accessories			EDP No.
								Bit	Plug	L-wrench	
GT-S5TFG	2.5~3.0	0.7~1.2	1,700	0.35	Rc 1/8	243	860	B36 Φ 2×70H	—	—	311215
GT-S5TG	2.5~3.0	0.7~1.2	1,700	0.35	Rc 1/4	260	920	A14 Φ 2×65G	BPB-2	—	311212
GT-S5TFB	3.0~4.0	1.2~2.0	1,200	0.35	Rc 1/8	243	830	B36 Φ 2×70H	—	—	311214
GT-S5TB	3.0~4.0	1.2~2.0	1,200	0.35	Rc 1/4	260	910	A14 Φ 2×65G	BPB-2	—	311211
GT-S5TFR	4.0~5.0	1.8~4.0	700	0.35	Rc 1/8	243	850	B36 Φ 2×70H	—	—	311213
GT-S5TR	4.0~5.0	1.8~4.0	700	0.35	Rc 1/4	260	930	A14 Φ 2×65G	BPB-2	—	311210
GT-S5TS	4.5~6.0	3.9~9.8	6,500	0.25	Rc 1/4	292	1,310	A14 Φ 2×65G	BPB-2	H3	324002

*Air pressure: 0.6MPa *Air hose diameter: 6.35mm *Overall length: Accessories and hanger parts not included. *Weight: Accessories not included.
 *Capacity is listed as instant reference and depends on operation conditions.

Bit installation anvil application

Unless otherwise mentioned, following type is a standard.

Standard type in Japan

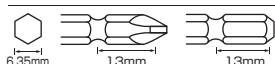

*Option: Following retainer anvil is available.



No. GT-C1400

Corner type impact wrench



Compact and lightweight, these impact wrenches have been designed to achieve the best possible balance in the hand, ensuring a secure hold for optimum nut/bolt work.



No. GT-C1400

Corner type impact wrench

Unique mechanism pursuing high hammering efficiency (PAT.P.)
Transverse-mounted hammer part transmitting hammering forces
directly to the anvil, it gives high power with its compact body.

HAND TOOLS

BITS & SOCKETS

ELECTRIC TOOLS

AIR TOOLS

STATIC SOLUTIONS

GASOLINE ENGINE TOOLS

Air Impact Wrenches Model Selection Chart

※Fastening torque is based on JIS B1083. (Metric coarse screw, friction coefficient μ : 0.15) The following selection chart is for referential purposes only.

		JISB1051 Strength Category																	
		3.6		4.6		4.8		5.6		5.8		6.8		8.8		10.9		12.9	
Screw diameter	Torque (N · m)	Applicabl Models	Torque (N · m)	Applicabl Models	Torque (N · m)	Applicabl Models	Torque (N · m)	Applicabl Models	Torque (N · m)	Applicabl Models	Torque (N · m)	Applicabl Models	Torque (N · m)	Applicabl Models	Torque (N · m)	Applicabl Models	Torque (N · m)	Applicabl Models	
M8	8.7	800	11.0	800	15.6	800	13.7	800 1000	19.2	800 1000	22.0	800 1000	29.3	1000	43.0	1000 1400	50.4	1000 1400	
M10	17.1	800 1000	21.6	1000	30.6	1000	27.0	1000	37.8	1000 1400	43.2	1000 1400	57.6	1000 1400	84.7	1000 1400	99.1	1400 1600	
M12	29.4	1000 1400	37.2	1000 1400	52.7	1400 1600	46.5	1400 1600	65.1	1400 1600	74.4	1400 1600	99.1	1400 1600	145.6	1600 2000	170.4	1600 2000	
M14	46.9	1400	59.3	1400 1600	84.0	1600 2000	74.1	1400 1600	103.8	1400 1600	118.6	1600	158.1	1600 2000	232.2	2000	271.7	2000	
M16	73.0	1600	92.2	1600	130.6	1600 2000	115.3	1600 2000	161.4	1600 2000	184.4	1600 2000	245.9	2000 2500	361.2	2000 2500	422.7	2000 2500	
M18	100.8	1600 2000	127.3	1600 2000	180.4	2000	159.2	2000	222.8	2000	254.7	2000 2500	350.2	2000 2500	498.8	2500	583.6	2500	
M20	142.7	2000	180.3	2000	255.4	2000	225.4	2000	315.5	2000 2500	360.6	2000 2500	495.9	2500	706.2	2500	826.4	2500 3800	
M22	196.6	2000	284.4	2500	351.9	2500	310.5	2500	434.7	2500	496.7	2500 3800	683.0	2500 3800	972.8	3800	1138.4	3800 4200 4800	
M24	245.9	3800	310.7	3800	440.1	3800	388.3	3800	543.7	3800	621.3	3800	854.3	3800	1216.8	3800 4200 4800	1423.9	3800 4200 4800	
M27	365.0	3800	461.0	3800	653.1	3800	576.2	3800	806.7	3800	922.0	3800	1267.7	3800 4200	1805.6	S55R	2112.9	S55R	
M30	494.6	3800	624.8	3800	885.2	3800	781.0	3800	1093.4	3800 4200 4800	1249.6	3800 4200 4800	1718.2	4200 4800 S55R	2447.2	S55R	2863.7		
M33	666.7	3800	842.1	3800	1193.0	3800	1052.6	3800	1473.7	4200 4800	1684.2	S55R	2315.8	S55R	3298.2		3859.6		
M36	862.5	3800	1089.5	4200 4800	1543.4	4200 4800 S55R	1767.8	4200 4800	1906.6	S55R	2178.9	S55R	2996.0		4267.1		4993.4		
M39	1119.6	4200 4800	1414.2	4200 4800	2003.5	S55R	1767.8	S55R	2474.9		2828.5		3889.2		5539.1		6482.0		
M42	1385.0	4200 4800	1749.4	S55R	2478.3	S55R	2186.8	S55R	3061.5		3498.8		4810.9		6851.9		8018.2		
M45	1733.0	S55R	2189.0	S55R	3101.1		2736.3		3830.8		4378.0		6019.8		8573.6		10033.0		
M48	2092.1	S55R	2642.6		3743.7		3303.3		4624.6		5285.3		7267.3		10350.3		12112.1		
M52	2692.9	S55R	3401.6		4818.9		4252.0		5953.8		6803.2		9354.4		13322.9		15590.6		

- 800 : GT-P6 II / S650 / S65W / P65W / S70WK / P60XW / S60XW
- 1000 : GT-P8 II / P80W / P80XW / C900
- 1400 : GT-1400P / P12 / C1400
- 1600 : GT-1600VPX / 1600VPH(L) / 1600VP(L) / P14J (L) / 1600P(L) / P14W / 1600JP
- 2000 : GT-2000PF / P18J(L) / 2000P(L) / S20RW / 1700BX
- 2500 : GT-2500LF / 2500PF / S220W
- 3800 : GT-3900VL / 3900VP / 3900V / 3800LX / S32RW
- 4200 : GT-4200LF / 4200PF / 4200L / 4200
- 4800 : GT-4800VL
- S55R : GT-S55R

HAND TOOLS

BITS & SOCKETS

ELECTRIC TOOLS

AIR TOOLS

STATIC SOLUTIONS

GASOLINE ENGINE TOOLS

 Machine Bolt Dia. **16mm** Compact, lightweight and high power with V shape hammer system.



No. GT-1600VPX

12.7 Retainer ring

④ Adjust dial

Rear exhaust



No. GT-1600VP

12.7 Retainer ring

④ Adjust dial

Rear exhaust



No. GT-1600VPL

12.7 Retainer ring

④ Adjust dial

Rear exhaust



No. GT-1600VPH

12.7 Retainer ring

④ Adjust dial

Rear exhaust

Oil-less type



No. GT-1600VPHL

12.7 Retainer ring

④ Adjust dial

Rear exhaust

Oil-less type



One point

GT-1600VPH/GT-1600VPHL Oilless mechanism

Completely oil-less model with rust-proofing and lubrication treatment on the air passage. Maintenance-free and environmental-friendly impact wrench, not causing oil mist.

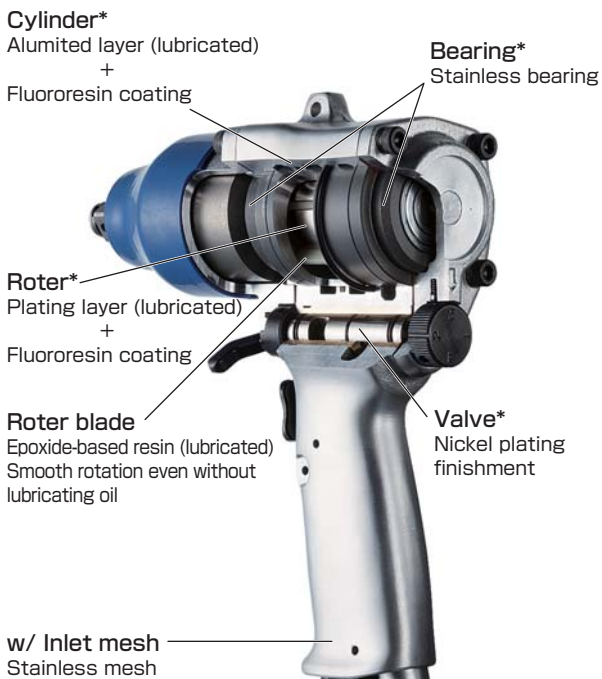

*Rust-proof and lubrication-free

Model No.	Capacity Ordinary Bolt Dia. (mm)	Torque Range (N-m)	Max. Torque (N-m)	No Load Speed (rpm)	Air Consumption (m ³ /min)	Hose Coupling	Air Hose Inner Dia. (mm)	Overall Length (mm)	Weight (kg)	Accessories		EDP No.
										Plug	L-wrench	
GT-1600VPX	16	49~294.2	360.0	8,200	0.4	Rc 1/4	6.35	169	1.48	BPB-2	H4	336013
GT-1600VP	16	49~304.0	366.7	8,500	0.4	Rc 1/4	6.35	171	1.91	BPB-2	H4	336010
GT-1600VPL	16	49~304.0	366.7	8,500	0.4	Rc 1/4	6.35	199	1.95	BPB-2	H4	336016
GT-1600VPH	16	49~284.3	352.0	8,200	0.4	Rc 1/4	6.35	174.5	1.75	BPB-2	H4	336012
GT-1600VPHL	16	49~284.3	352.0	8,200	0.4	Rc 1/4	6.35	202.5	1.8	BPB-2	H4	336017

•Air pressure: 0.6MPa •Overall length and Weight: Accessories not included. •Capacity is listed as instant reference and depends on operation conditions.

HAND TOOLS

BITS & SOCKETS

ELECTRIC TOOLS

AIR TOOLS

STATIC SOLUTIONS

GASOLINE ENGINE TOOLS

VESSEL Air motor tightens really fast Air Impact Wrenches Super Light V-Hammer

 Machine Bolt Dia. **39mm** Compact, lightweight and high power with V shape hammer system.



No. GT-3900VP

25.4 Retainer ring

 Adjust dial
Rear exhaust



No. GT-3900VL

25.4 Retainer ring

 Adjust dial

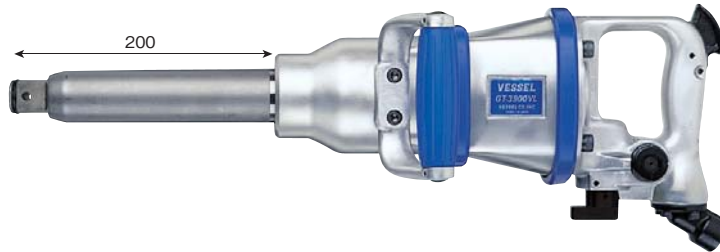

No. GT-3900V

25.4 Retainer ring

 Adjust dial



 Machine Bolt Dia. **48mm** Compact, lightweight and high power with V shape hammer system.



No. GT-4800VL

25.4 Pin-lock

 Adjust dial

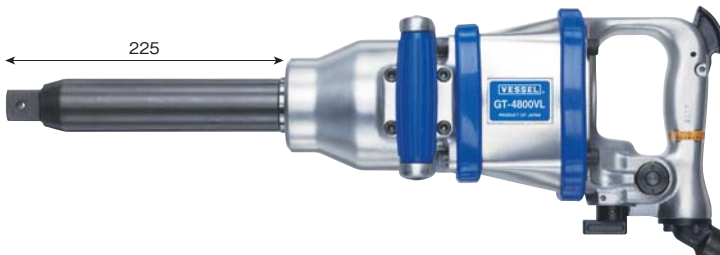

Model No.	Capacity Ordinary Bolt Dia. (mm)	Torque Range (N·m)	Max. Torque (N·m)	No Load Speed (rpm)	Air Consumption (m ³ /min)	Hose Coupling	Air Hose Inner Dia. (mm)	Overall Length (mm)	Weight (kg)	Accessories		EDP No.
										Plug	L-wrench	
GT-3900VP	39	490~1716	2013.4	4,200	0.7	Rc 3/8	12.7	268	7.95	BPB-3	H5,H6	336118
GT-3900VL	39	490~1716	2094.9	4,200	0.7	Rc 1/2	12.7	524	8.95	BPB-4	H5,H6	336117
GT-3900V	39	490~1716	2094.9	4,200	0.7	Rc 1/2	12.7	358.6	8.2	BPB-4	H5,H6	336113
GT-4800VL	48	343~2010	2542.1	3,200	1.0	Rc 1/2	12.7	559	12.8	1/2"×1/2" (hose nipple)	H6	336121

·Air pressure: 0.6MPa ·Overall length and Weight: Accessories not included. ·Capacity is listed as instant reference and depends on operation conditions.

HAND TOOLS

BITS & SOCKETS

ELECTRIC TOOLS

AIR TOOLS

STATIC SOLUTIONS

GASOLINE ENGINE TOOLS

Air Impact Wrenches Lightweight F-Hammer Air motor tightens really fast **VESSEL**

 Machine Bolt Dia. **20mm** Models with the best balance between strength and lightness.



No. GT-2000PF

19 Retainer ring

4 Adjust dial

Rear exhaust/Noise reducer



 Machine Bolt Dia. **25mm** Models with the best balance between strength and lightness.



No. GT-2500PF

19 Retainer ring

4 Adjust dial

Rear exhaust/Noise reducer



178



No. GT-2500LF

19 Retainer ring

4 Adjust dial

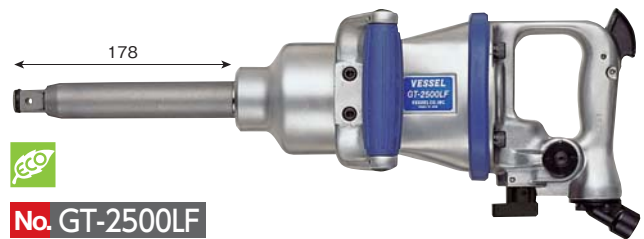

 Machine Bolt Dia. **39mm** Models with the best balance between strength and lightness.



See P153 One point→

No. GT-3800LX PAT.

25.4 Retainer ring

3 Adjust dial

Rear exhaust/
Noise reducer

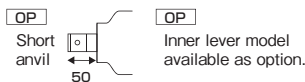

No. GT-3800PX

25.4 Retainer ring

Rear exhaust/Noise reducer



Model No.	Capacity Ordinary Bolt Dia. (mm)	Torque Range (N-m)	Max. Torque (N-m)	No Load Speed (rpm)	Air Consumption (m ³ /min)	Hose Coupling	Air Hose Inner Dia. (mm)	Overall Length (mm)	Weight (kg)	Accessories		EDP No.
										Plug	L-wrench	
GT-2000PF	20	98~460.9	542.7	5,500	0.43	Rc 1/4	9.5	210	3.5	BPB-2	H5	331298
GT-2500PF	25	147~961	1187.7	3,200	0.6	Rc 3/8	9.5	242	6.2	BPB-3	H5	335326
GT-2500LF	25	245~961	1315.2	4,400	0.7	Rc 3/8	9.5	478	7.3	BPB-3	H5,H6	335321
GT-3800LX	39	490~1607	2082.3	4,100	0.7	Rc 1/2	12.7	520	9.8	BPB-4	H5	335373
GT-3800PX	39	490~1607	2063.0	4,100	0.7	Rc 1/2	12.7	270	8.9	BPB-4	H5	335389

*Air pressure: 0.6MPa *Overall length and Weight: Accessories not included. *Capacity is listed as instant reference and depends on operation conditions.

HAND TOOLS

BITS & SOCKETS

ELECTRIC TOOLS

AIR TOOLS

STATIC SOLUTIONS

GASOLINE ENGINE TOOLS

VESSEL Air motor tightens really fast Air Impact Wrenches Lightweight F-Hammer

Machine Bolt Dia. **42mm** Models with the best balance between strength and lightness.

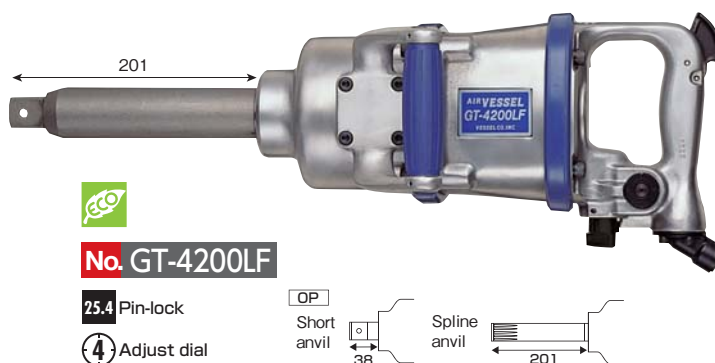

Machine Bolt Dia. **52mm** Models with the best balance between strength and lightness.



Model No.	Capacity Ordinary Bolt Dia. (mm)	Torque Range (N·m)	Max. Torque (N·m)	No Load Speed (rpm)	Air Consumption (ml/min)	Hose Coupling	Air Hose Inner Dia. (mm)	Overall Length (mm)	Weight (kg)	Accessories		EDP No.
										Plug	L-wrench	
GT-4200PF	42	343~1863	2250	2,500	1.0	Rc 3/8	12.7	297	11.5	BPB-3	H6	335388
GT-4200LF	42	343~1863	2250	3,200	1.0	Rc 1/2	12.7	547	13.3	BPB-4	H6	335385
GT-S55R	52	343~2450	3000	2,800	1.2	Rc 1/2	12.7	610	17.0	1/2"×1/2" (hose nipple)	H6	335391

*Air pressure: 0.6MPa *Overall length and Weight: Accessories not included. *Capacity is listed as instant reference and depends on operation conditions.

One point

Grip shape specialized for working with tires

Designed so that the center of gravity comes to the center of the whole body with the socket and air hose attached.

Very recommended to large tire shops replacing many tires a day.



No. GT-3800LX

HAND TOOLS

BITS & SOCKETS

ELECTRIC TOOLS

AIR TOOLS

STATIC SOLUTIONS

GASOLINE ENGINE TOOLS

Air Impact Wrenches Single Hammer Air motor tightens really fast **VESSEL**

 Machine Bolt Dia. **6~8mm** For strong tightening work. Excellent durability.



No. GT-S650

9.5 Retainer ring

4 Adjust dial



No. GT-P6II

9.5 Retainer ring

3 Adjust dial

 Machine Bolt Dia. **8~10mm** For strong tightening work. Excellent durability.



No. GT-P8II

12.7 Retainer ring

3 Adjust dial

 Machine Bolt Dia. **10mm** Corner type impact wrench.



No. GT-C900 **NEW PAT.P.**

9.5 Retainer ring

4 Adjust dial

 Machine Bolt Dia. **6~8mm** Corner type impact wrench.



No. GT-S600C

9.5 Pin-lock

4 Adjust dial

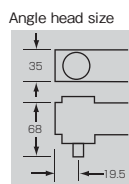

 Machine Bolt Dia. **14mm** Corner type impact wrench.



No. GT-C1400 **PAT.P.**

12.7 Retainer ring

4 Adjust dial



← See P144

Model No.	Capacity Ordinary Bolt Dia. (mm)	Torque Range (N·m)	Max. Torque (N·m)	No Load Speed (rpm)	Air Consumption (ml/min)	Hose Coupling	Air Hose Inner Dia. (mm)	Overall Length (mm)	Weight (kg)	Accessories		EDP No.
										Plug	L-wrench	
GT-S650	6~8	49~121.6	140.5	7,500	0.35	Rc 1/4	6.35	210	1.3	BPB-2	H4	331221
GT-P6II	6~8	49~121.6	140.5	8,500	0.38	Rc 1/4	6.35	146	1.43	BPB-2	H4	331234
GT-P8II	8~10	49~259.8	295.3	7,500	0.4	Rc 1/4	6.35	166	1.89	BPB-2	H4	331244
GT-C900	10	49~100	131.7	7,000	0.25	Rc 1/4	6.35	257	1.9	BPB-2	H3,H4	331228
GT-S600C	6~8	25~47	51.5	7,300	0.35	Rc 1/4	6.35	255	1.87	BPB-2	H4	331226
GT-C1400	14	49~220	241.8	4,500	0.3	Rc 1/4	6.35	277	2.8	BPB-2	H4,H5	331227

*Air pressure: 0.6MPa *Overall length and Weight: Accessories not included. *Capacity is listed as instant reference and depends on operation conditions.

HAND TOOLS

BITS & SOCKETS

ELECTRIC TOOLS

AIR TOOLS

STATIC SOLUTIONS

GASOLINE ENGINE TOOLS

VESSEL Air motor tightens really fast Air Impact Wrenches Single Hammer

 Machine Bolt Dia. **14mm** For strong tightening work. Excellent durability.



No. GT-P12

12.7 Retainer ring

④ Adjust dial



No. GT-1400P

12.7 Retainer ring

④ Adjust dial



 Machine Bolt Dia. **16mm** For strong tightening work. Excellent durability. Long anvil model also available.



No. GT-P14J

12.7 Retainer ring

④ Adjust dial



No. GT-P14JL

12.7 Retainer ring

④ Adjust dial



No. GT-1600P

12.7 Retainer ring

④ Adjust dial



No. GT-1600PL

12.7 Retainer ring

④ Adjust dial



Model No.	Capacity Ordinary Bolt Dia. (mm)	Torque Range (N·m)	Max. Torque (N·m)	No Load Speed (rpm)	Air Consumption (ml/min)	Hose Coupling	Air Hose Inner Dia. (mm)	Overall Length (mm)	Weight (kg)	Accessories		EDP No.
										Plug	L-wrench	
GT-P12	12~14	49~294.1	344.9	7,500	0.4	Rc 1/4	6.35	185	2.3	BPB-2	H4	331262
GT-1400P	12~14	49~294.1	344.9	7,000	0.35	Rc 1/4	6.35	182	2.25	BPB-2	H4	331265
GT-P14J	14~16	75~323.6	409.6	6,500	0.42	Rc 1/4	6.35	197	2.95	BPB-2	H5	331272
GT-P14JL	14~16	75~323.6	365.0	6,500	0.42	Rc 1/4	6.35	226	3.0	BPB-2	H5	331276
GT-1600P	14~16	75~308.9	362.3	6,700	0.36	Rc 1/4	6.35	196	2.7	BPB-2	H5	331275
GT-1600PL	14~16	75~308.9	338.8	6,700	0.36	Rc 1/4	6.35	224	2.8	BPB-2	H5	331277

·Air pressure: 0.6MPa ·Overall length and Weight: Accessories not included. ·Capacity is listed as instant reference and depends on operation conditions.

HAND TOOLS

BITS & SOCKETS

ELECTRIC TOOLS

AIR TOOLS

STATIC SOLUTIONS

GASOLINE ENGINE TOOLS

Air Impact Wrenches Single Hammer Air motor tightens really fast **VESSEL**

 Machine Bolt Dia. **20mm** For strong tightening work. Excellent durability. Long anvil model also available.



No. GT-P18J

19 Retainer ring

4 Adjust dial



No. GT-P18JL

19 Retainer ring

4 Adjust dial

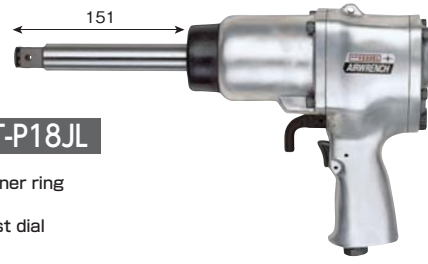

No. GT-2000P

19 Retainer ring

4 Adjust dial



No. GT-2000PL

19 Retainer ring

4 Adjust dial

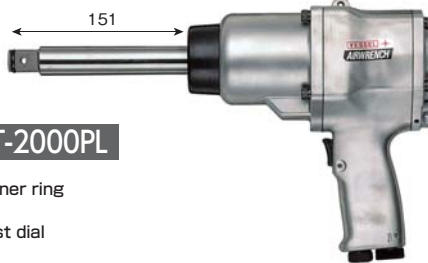

 Machine Bolt Dia. **33mm** For strong tightening work.



No. GT-P32J

25.4 Pin-lock

4 Adjust dial



 Machine Bolt Dia. **42mm** For strong tightening work.

No. GT-4200P

25.4 Pin-lock

4 Adjust dial



No. GT-4200L

25.4 Pin-lock

4 Adjust dial

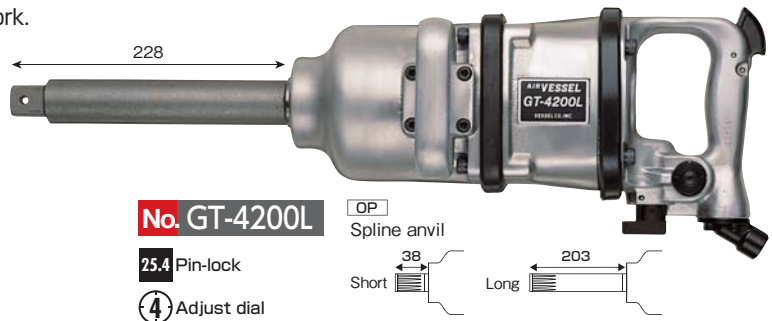

No. GT-4200

25.4 Pin-lock

4 Adjust dial

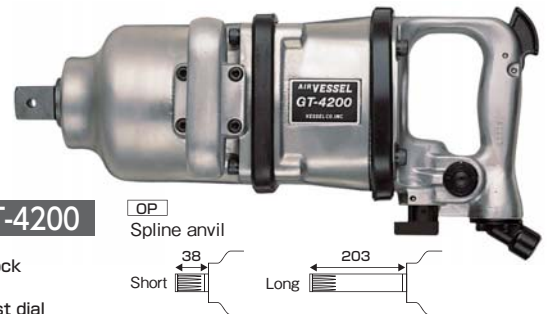

Model No.	Capacity Ordinary Bolt Dia. (mm)	Torque Range (N·m)	Max. Torque (N·m)	No Load Speed (rpm)	Air Consumption (ml/min)	Hose Coupling	Air Hose Inner Dia. (mm)	Overall Length (mm)	Weight (kg)	Accessories		EDP No.
										Plug	L-wrench	
GT-P18J	16~20	98~470.7	556.5	5,000	0.52	Rc 1/4	9.5	240	4.2	BPB-2	H5	331292
GT-P18JL	16~20	98~441.3	471.4	5,000	0.52	Rc 1/4	9.5	353	4.7	BPB-2	H5	331296
GT-2000P	16~20	98~470.7	556.5	5,000	0.45	Rc 1/4	9.5	241	4.3	BPB-2	H5	331295
GT-2000PL	16~20	98~441.3	471.4	5,000	0.45	Rc 1/4	9.5	354	4.7	BPB-2	H5	331297
GT-P32J	33	343~1569	1906.9	3,700	0.8	Rc 3/8	12.7	264	11.2	BPB-3	H6	335181
GT-4200P	27~42	490~1863	2250	2,500	1.0	Rc 3/8	12.7	315	14.2	BPB-3	H6	331335
GT-4200L	27~42	490~1863	2250	3,200	1.0	Rc 1/2	12.7	593	15.9	BPB-4	H6	335378
GT-4200	27~42	490~1863	2267	3,200	1.0	Rc 1/2	12.7	403	14.9	BPB-4	H6	335377

*Air pressure: 0.6MPa · Overall length and Weight: Accessories not included. · Capacity is listed as instant reference and depends on operation conditions.

HAND TOOLS

BITS & SOCKETS

ELECTRIC TOOLS

AIR TOOLS

STATIC SOLUTIONS

GASOLINE ENGINE TOOLS

VESSEL Air motor tightens really fast Air Impact Wrenches Double Hammer

Machine Bolt Dia. **6~8mm** Low noise and low vibration. High power and high durability.

Oil Xtra Series



No. GT-S60XW

9.5 Pin-lock

3 Adjust dial

Noise reducer/Rear exhaust

↓ See One point



No. GT-P60XW

9.5 Pin-lock

3 Adjust dial

Noise reducer/Rear exhaust

↓ See One point



Machine Bolt Dia. **8~10mm** Low noise and low vibration. High power and high durability.



No. GT-P80XW

12.7 Pin-lock

4 Adjust dial

Noise reducer/Rear exhaust

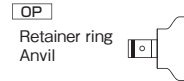

Model No.	Capacity Ordinary Bolt Dia. (mm)	Torque Range (N·m)	Max. Torque (N·m)	No Load Speed (rpm)	Air Consumption (ml/min)	Hose Coupling	Air Hose Inner Dia. (mm)	Overall Length (mm)	Weight (kg)	Accessories			EDP No.
										Socket	Plug	L-wrench	
GT-S60XW	6~8	49~116.8	135.0	7,500	0.38	Rc 1/4	6.35	192	1.0	—	BPB-2	—	324022
GT-P60XW	6~8	49~116.8	135.0	7,500	0.38	Rc 1/4	6.35	169.4	1.1	—	BPB-2	—	324020
GT-P80XW	8~10	49~229.7	242.9	7,000	0.4	Rc 1/4	6.35	163.5	1.48	—	BPB-2	H4	324049

*Air pressure: 0.6MPa *Overall length and Weight: Accessories not included. *Capacity is listed as instant reference and depends on operation conditions.

One point

GT-S60XW / GT-P60XW Quest for easy-to-use tools

Flexible ways to hold. Easy-to-hold grip and balanced body improve workability.

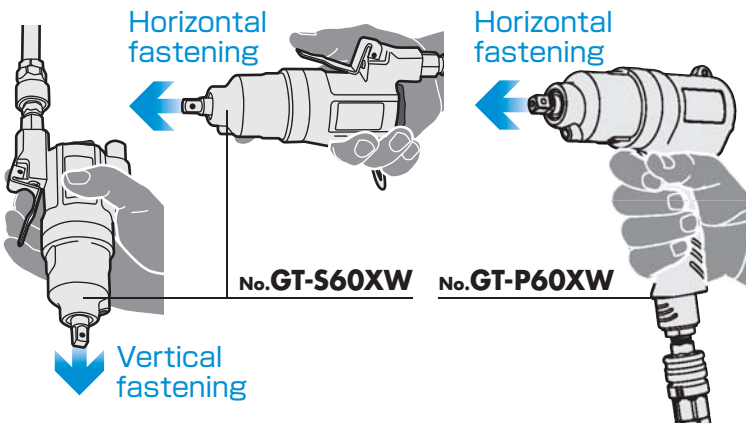

Adjustor and switch to change right/left rotation

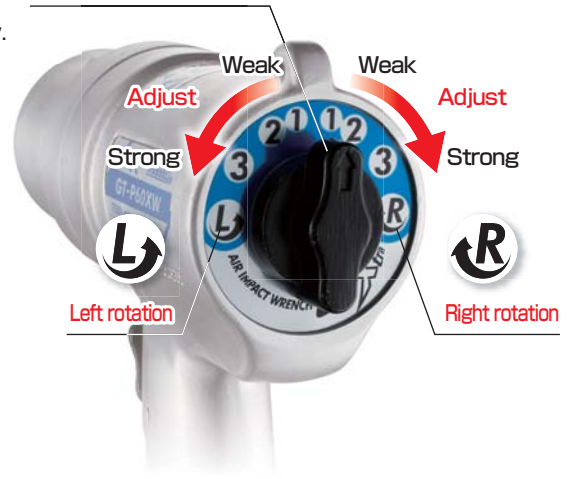

HAND TOOLS

BITS & SOCKETS

ELECTRIC TOOLS

AIR TOOLS

STATIC SOLUTIONS

GASOLINE ENGINE TOOLS

Air Impact Wrenches Double Hammer Air motor tightens really fast **VESSEL**

 Machine Bolt Dia. **5~6mm** For powerful constant fastening. Excellent durability.



No. GT-S6MLRB

9.5 Pin-lock

3 Adjust dial

 Machine Bolt Dia. **6~8mm** Corner type impact wrench.



No. GT-S60CW

9.5 Pin-lock

4 Adjust dial

Angle head size

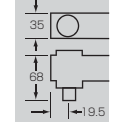

 Machine Bolt Dia. **6~8mm** For powerful constant fastening. Excellent durability.



No. GT-S65W

9.5 Pin-lock

4 Adjust dial



No. GT-P65W

9.5 Pin-lock

3 Adjust dial



No. GT-S70WK

9.5 Pin-lock

4 Adjust dial

Noise reducer/Rear exhaust

 Machine Bolt Dia. **8~10mm** For powerful constant fastening.



No. GT-P80W

12.7 Pin-lock

3 Adjust dial

 Machine Bolt Dia. **12~16mm** For powerful constant fastening.



No. GT-P14W

12.7 Pin-lock

4 Adjust dial

Model No.	Capacity Ordinary Bolt Dia. (mm)	Torque Range (N·m)	Max. Torque (N·m)	No Load Speed (rpm)	Air Consumption (ml/min)	Hose Coupling	Air Hose Inner Dia. (mm)	Overall Length (mm)	Weight (kg)	Accessories			EDP No.
										Socket	Plug	L-wrench	
GT-S6MLRB	5~6	10~39	—	8,500	0.25	G 1/4	6.35	200	1.1	A/F10	BPN-2F	—	311103
GT-P65W	6~8	49~121.6	140.5	8,500	0.38	Rc 1/4	6.35	146	1.43	A/F10	BPB-2	H4	324038
GT-S65W	6~8	49~121.6	140.5	7,500	0.35	Rc 1/4	6.35	210	1.3	A/F10	BPB-2	H4	324008
GT-S70WK	6~8	85~176.5	193.5	7,000	0.39	Rc 1/4	6.35	231	1.3	—	BPB-2	H4	324017
GT-S60CW	6~8	25~47	51.5	7,300	0.35	Rc 1/4	6.35	255	1.87	A/F10	BPB-2	H4	324011
GT-P80W	8~10	49~259.8	295.3	7,500	0.4	Rc 1/4	6.35	164	1.89	A/F14	BPB-2	H4	324048
GT-P14W	12~16	49~421.6	505.0	6,400	0.47	Rc 1/4	9.5	200	3.2	A/F22	BPB-2	H5	324073

*Air pressure: 0.6MPa *Overall length and Weight: Accessories not included. *Capacity is listed as instant reference and depends on operation conditions.

HAND TOOLS

BITS & SOCKETS

ELECTRIC TOOLS

AIR TOOLS

STATIC SOLUTIONS

GASOLINE ENGINE TOOLS

Air Impact Wrenches Double Hammer

Machine Bolt Dia. **20mm** For powerful constant fastening.



No. GT-S20RW

19 Pin-lock

4 Adjust dial

Machine Bolt Dia. **33mm** For powerful constant fastening.



No. GT-S32RW

25.4 Pin-lock

4 Adjust dial

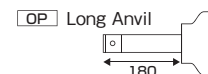

Model No.	Capacity Ordinary Bolt Dia. (mm)	Torque Range (N·m)	Max. Torque (N·m)	No Load Speed (rpm)	Air Consumption (ml/min)	Hose Coupling	Air Hose Inner Dia. (mm)	Overall Length (mm)	Weight (kg)	Accessories		EDP No.
										Plug	L-wrench	
GT-S20RW	20	75~610	928	4,800	0.9	Rc 3/8	9.5	300	5.4	BPB-3	H5	324101
GT-S32RW	33	343~1,569	1801.2	3,600	1.0	Rc 1/2	12.7	380	12.2	BPB-4	H5,H6	324088

·Air pressure: 0.6MPa ·Overall length and Weight: Accessories not included. ·Capacity is listed as instant reference and depends on operation conditions.

Air Impact Wrenches Twin Hammer

Machine Bolt Dia. **16mm** Well balanced, less shock from the impact.



No. GT-1600JP NEW

12.7 Retainer ring

3 Adjust dial

Rear exhaust

Machine Bolt Dia. **20mm** Well balanced, less shock from the impact.



No. GT-1700BX NEW

12.7 Retainer ring

4 Adjust dial

Rear exhaust

Oil lubricating mechanism
Oil protects the hammer unit and reduces irritating noises, preventing parts from being burned.

Model No.	Capacity Ordinary Bolt Dia. (mm)	Torque Range (N·m)	Max. Torque (N·m)	No Load Speed (rpm)	Air Consumption (ml/min)	Hose Coupling	Air Hose Inner Dia. (mm)	Overall Length (mm)	Weight (kg)	Accessories		EDP No.
										Plug	L-wrench	
GT-1600JP	16	50~220	280	10,000	0.6	Rc1/4	6.35	109	1.4	BPB-2	—	336014
GT-1700BX	20	Right rotation 49~450 Left rotation 75~500	Right rotation 480 Left rotation 540	Right rotation 7,000 Left rotation 8,000	0.9	Rc1/4	6.35	192	2.2	—	—	331286

·Air pressure: 0.6MPa ·Overall length and Weight: Accessories not included. ·Capacity is listed as instant reference and depends on operation conditions.

Air Ratchet Wrenches

 Machine Bolt Dia. **10mm** This ratchet tightening system makes it possible to fine-tune the wrenching torque.

Mini type



The exhaust cover is 360-degree rotatable.

No. GT-R10M

9.5 Ball-lock

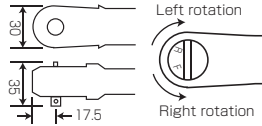

No. GT-R10

9.5 Ball-lock

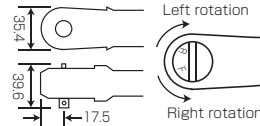

Model No.	Capacity Ordinary Bolt Dia. (mm)	No Load Speed (rpm)	Air Consumption (ml/min)	Hose Coupling	Air Hose Inner Dia. (mm)	Overall Length (mm)	Weight (kg)	Accessories		EDP No.
								Plug		
GT-R10M	10	250	0.3	Rc 1/4	6.35	170	500	BPB-2		339003
GT-R10	10	160	0.4	Rc 1/4	6.35	297	1,090	BPB-2		339001

*Air pressure: 0.6MPa *Overall length and Weight: Accessories not included.

Air Impact Wrenches, Torque Control Type

 Machine Bolt Dia. **6~8mm** Automatic suspensions by torque set-up



No. GT-P6T

9.5 Pin-lock

Adjust dial

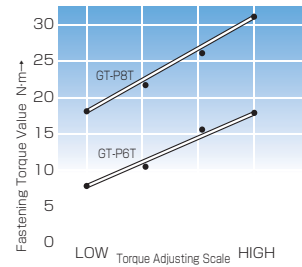

Working air pressure 0.6MPa
 ※The above is an actual measurement value by our specified torque tester. It depends upon screw, bolts, nuts, or material differences.

 Machine Bolt Dia. **8~10mm** Automatic suspensions by torque set-up



No. GT-P8T

12.7 Pin-lock

Adjust dial

Model No.	Capacity Ordinary Bolt Dia. (mm)	Torque Range (N·m)	No Load Speed (rpm)	Air Consumption (ml/min)	Hose Coupling	Air Hose Inner Dia. (mm)	Overall Length (mm)	Weight (kg)	Accessories		EDP No.
									Plug	L-wrench	
GT-P6T	6~8	7.8~17.6	3,000	0.27	Rc 1/4	6.35	246	1.5	BPB-2	H3,H4	324003
GT-P8T	8~10	17.6~31.4	2,500	0.31	Rc 1/4	6.35	266	2.2	BPB-2	H3,H4	324005

*Air pressure: 0.6MPa *Overall length and Weight: Accessories not included. *Capacity is listed as instant reference and depends on operation conditions.

HAND TOOLS

BITS & SOCKETS

ELECTRIC TOOLS

AIR TOOLS

STATIC SOLUTIONS

GASOLINE ENGINE TOOLS

No. GT-HPS160 Power Scaler



The barycenter is at the front side, alleviating the strain on your wrist. Effortless operation is possible by just pressing the needles on welding spatters, slugs, etc. The impact does not catch your hand so the needles do not spread out as much, making it easier to work.



No. GT-HPS160 Power Scaler

Even in places set deep at the back where the pistol types cannot reach, it can be handled smoothly.

Power Scaler

- The barycenter is at the front side, alleviating the strain on your wrist. Downward-facing work on a welding bench is easy and effortless.
- With a new shape similar to the straight type, it can be handled smoothly even in places set deep at a place where the pistol types cannot reach.
- Needles do not spread as much, enabling to aim at the welding spatters and to perform a precise work.
- Easy to replace needles without any tools.
- The hose rotates 360°, making it easier to handle. Equipped with a filter to prevent dust coming in from the air inlet.
- Convenient for removing spatters or slugs, peeling off coating and removing rust.

Needle ϕ 2mm

No. GT-HPS160 **NEW**

- Needle ϕ 2mm \times 180mm 29pcs.
- Accessories ·Hose set 1set
·Hydraulic oil for hammer unit 1pc. (VG-10·White)
·Replacement needles..... 29pcs. (ϕ 2mm \times 180mm)



Needle ϕ 3mm

No. GT-HPS200 **NEW**

- Needle ϕ 3mm \times 180mm 12pcs.
- Accessories ·Hose set 1set
·Hydraulic oil for hammer unit 1pc. (VG-10·White)
·Replacement needles..... 12pcs. (ϕ 3mm \times 180mm)



Model No.	Piston diameter (mm)	Needle stroke (mm)	Number of impacts (min ⁻¹)	Air Consumption (m ³ /min)	Inlet bushing	Appropriate Air Pressure (MPa)	Air hose inner diameter (mm)	Overall Length (mm)	Weight (kg)	EDP No.
GT-HPS160	16	18	4000	0.22	Rc 1/4	0.6	6.35	380	1.47	310650
GT-HPS200	20	20	3700	0.26	Rc 1/4	0.6	6.35	400	1.9	310651

*Overall length and weight : Accessories included

Needles for Power Scalers

No. HPSN-215 **NEW**



No. HPSN-318 **NEW**



No. HPSN-218 **NEW**



For GT-HPS160 (100pieces)

Model No.	Contents	EDP No.
HPSN-215	ϕ 2mm \times 150mm 100pcs.	350151
HPSN-218	ϕ 2mm \times 180mm 100pcs.	350150

For GT-HPS200 (50pieces)

Model No.	Contents	EDP No.
HPSN-318	ϕ 3mm \times 180mm 50pcs.	350152

No. GT-BS12

Air Belt Sanders



The center of the arm becomes the center of gravity. This belt has been designed in an offset position so that it becomes aligned with the center of the arm when the unit is taken up. This slight difference in balance makes a big difference in reducing fatigue. A major ergonomic achievement.

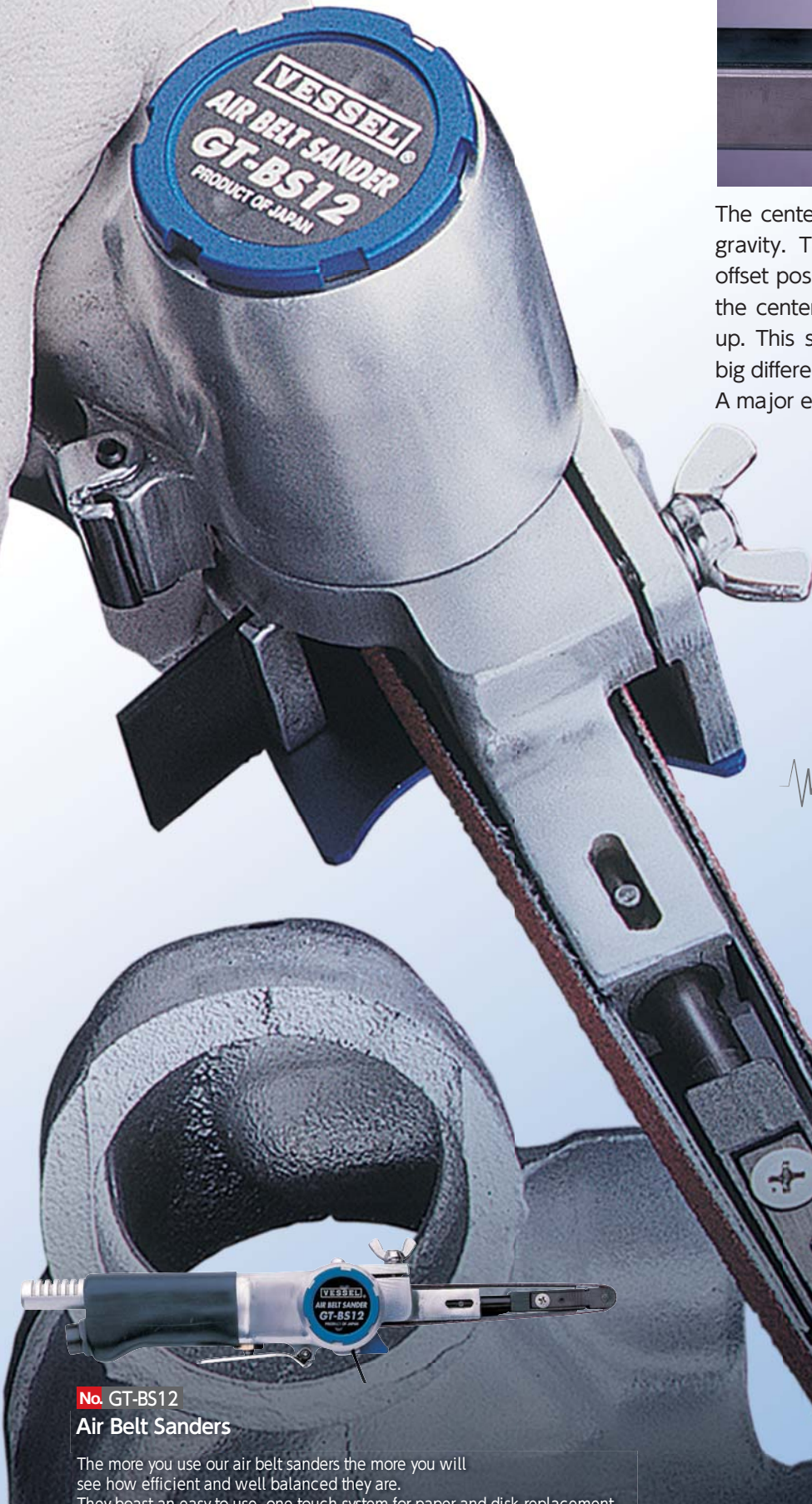

No. GT-BS12

Air Belt Sanders

The more you use our air belt sanders the more you will see how efficient and well balanced they are. They boast an easy-to-use, one-touch system for paper and disk replacement, and their delicate balance achieves a major reduction in fatigue.

HAND TOOLS

BITS & SOCKETS

ELECTRIC TOOLS

AIR TOOLS

STATIC SOLUTIONS

GASOLINE ENGINE TOOLS

Air Belt Sanders

Belt Width **12mm/10mm** Compact and lightweight.



No. GT-BS12 PAT.

With noise reducer
Accessories
Sand belt #60...2pcs.
#80...1pc.

Belt Width **20mm** Roller head can be chosen.



No. GT-BS20 PAT.

Aluminum roller head
With noise reducer



Aluminum
For heavy-duty sanding.

Accessories
Sand belt #60...2pcs.
#80...1pc.



OP
Bar grip
(Auxiliary handle)

Belt Width **30mm** Roller head can be chosen.

No. GT-BS30 PAT.

Aluminum roller head
With noise reducer



Aluminum
For heavy-duty sanding.

No. GT-BS30W PAT.

Urethane roller head
With noise reducer



Urethane
For undulated and curved surfaces.



Accessories
Bar grip (Auxiliary handle) ... 1pc.
Sand belt #60...2pcs.
#80...1pc.

Model No.	Applicable Belt Size	Belt Circumferential Speed (m/min)	Working Air Pressure (MPa)	No Load Speed (rpm)	Air Consumption (m ³ /min)	Hose Coupling	Overall Length (mm)	Weight (g)	Accessories		EDP No.
									Plug	L-wrench	
GT-BS12	12mm/10mm×330mm	1,100	0.6	17,000	0.52	Rc 1/4	311	840	BPB-2	H1.5	310621
GT-BS20	20mm×520mm	2,600	0.6	16,500	0.6	Rc 1/4	398	1,300	BPB-2	H2	310622
GT-BS30	30mm×540mm	2,040	0.6	13,000	0.72	Rc 1/4	374	1,930	BPB-2	H2.5	310624
GT-BS30W											310625

*Total length: When mounted with belt.

Air Disk Sanders

Disk Dia. **50mm** Low speed of 5000 rpm & High torque.



Collet chuck
φ6mm



Sand belt #60...2pcs.
#80...1pc.

No. GT-DS50A

With noise reducer

Accessories

Flap wheel #60...1 pc.
Fiber wheel #600...1 pc.
Pitatto holder...1 pc.
Pitatto disk paper #60...3 pcs.



Disk bolt

Collet chuck (φ3mm, φ1/4", φ1/8")



Disk Dia. **100mm** Low speed of 5000 rpm & High torque.



M10 disk nut



No. GT-DS50B

With noise reducer

Accessories

Protective cover
Disk nut
Pin wrench

Model No.	Disk Dia. (mm)	No Load Speed (rpm)	Air Consumption (m ³ /min)	Hose Coupling	Air Hose Inner Dia. (mm)	Overall Length (mm)	Weight (g)	Tip Tool Installation Part	Accessories		EDP No.
									Plug	Spanner	
GT-DS50A	50	5,000	0.65	Rc 1/4	6.35	211	935	Collet chuck φ6mm	BPB-2	H11,H15	310635
GT-DS50B	100	5,000	0.65	Rc 1/4	6.35	211	1,150	M10 Disk nut	BPB-2	Pin spanner,H15	310636

*Air pressure: 0.6MPa

HAND TOOLS

BITS & SOCKETS

ELECTRIC TOOLS

AIR TOOLS

STATIC SOLUTIONS

GASOLINE ENGINE TOOLS

Endless belts for air belt sander

No. CB12 Ceramic Endless Belt
(for GT-BS12)



Model No.	Size	Grit No.	Quantity	EDP No.
CB12-60	12mm×330mm	#60	50	350061
CB12-80	12mm×330mm	#80	50	350062
CB12-120	12mm×330mm	#120	50	350064

No. ZB20 Zirconia Endless Belt
(for GT-BS12)

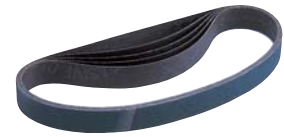

Model No.	Size	Grit No.	Quantity	EDP No.
ZB20-40	20mm×520mm	#40	20	350067
ZB20-60	20mm×520mm	#60	20	350068
ZB20-80	20mm×520mm	#80	20	350069

Air Disk Sander Wheel (For DS50A) [See P162 One point→](#)

No. PD-P60 Pitatto Disk Paper

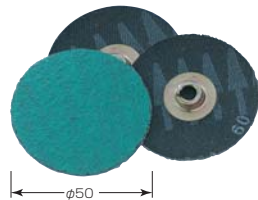

No. PD-P6 Pitatto Holder

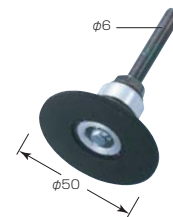

No. FL-60,120 Flap Wheel

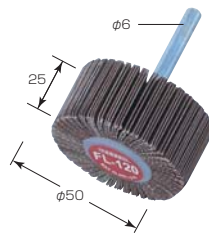

No. FB-400,600,1000 Fiber Wheel



Model No.	Grit No.	Max. Circumferential Speed (rpm)	Material	Use	Quantity	EDP No.
PD-P60	Z60	20,000	Zirconia	Thin pressed plate deburring, surfacing, etc.	50	350111
PD-P6	—	—	Rubber (Pad)	For Pitatto disk paper	1	350116
FL-60	A60	20,000	Alumina	Deburring, spatter removal Cylinder lining polishing, surfacing, etc.	5	350101
FL-120	A120	20,000	Alumina	Deburring, spatter removal Cylinder lining polishing, surfacing, etc.	5	350102
FB-400	400	10,000	Unwoven cloth	Dirt removal, cleaning prior to welding or plating, burn removal after welding, etc.	5	350106
FB-600	600	10,000	Unwoven cloth	Dirt removal, cleaning prior to welding or plating, burn removal after welding, etc.	5	350107
FB-1000	1000	10,000	Unwoven cloth	Dirt removal, cleaning prior to welding or plating, burn removal after welding, etc.	5	350108

Wheels to Remove Rust / Stains (For DS50B) [See P162 One point→](#)

No. HMW10 Hammer Wheel **PAT.P.**



No. BHW10 Brush Wheel



Model No.	Max. Circumferential Speed (rpm)	Material	Use	Quantity	EDP No.
HMW10	5,000	SUS	Slag and spatter removal after welding, etc.	1	350121
BHW10	5,000	Abrasive grain nylon	Steel plate rust removal, aluminum cast finishing, etc.	1	350122

Disk Dia. 100mm Handy & powerful grinder pursuing safety and usability.



No. GT-DG100



OP
Bar grip (Auxiliary handle)

Model No.	Grindstone Size Outer Dia.×Thickness×Hole Dia. (mm)	Belt Circumferential Speed (m/min)	No Load Speed (rpm)	Air Consumption (m ³ /min)	Hose Coupling	Overall Length (mm)	Height (mm)	Weight (g)	Accessories		EDP No.
									Plug	L-wrench	
GT-DG100	100×6×15	4,300	13,500	0.7	Rc 1/4	205	92	1,390	BPB-2	H6	310630

·Air pressure: 0.6MPa ·Air hose diameter: 6.35mm

One point

Application

Wheel

Tools

- For grinding inner cylinder and plane surface and removing burr (Grinding, welding press)

← Flap Wheel



No. FL-60
No. FL-120

- For removing dirt, cleaning welded parts and plate processed parts, removing scuffing, feathering, etc.

← Fiber Wheel



No. FB-400
No. FB-600
No. FB-1000

- For removing burr from thin metal sheet press, cutter mark, burr from aluminum casting, wood work, etc.

← Pitatto Holder + Pitatto Disk Paper



No. PD-P6
No. PD-P60

- For removing slag and spatter after welding, rust on steel members, burr on foundry pieces, shells on ship bottom, etc.

← Hammer Wheel



No. HMW10

- For removing rust on steel members, grain pattern finishing, finishing for aluminum casting

← Brush Wheel

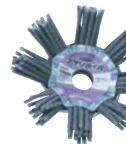

No. BHW10

No. GT-DS50A



No. GT-DS50B



Collet chuck $\phi 3\text{mm}$ High rotation speed and minimum core deviation, realizing an effortless and smooth grinding performance

No. GT-MG75S

75,000 rpm



No. GT-MG75SAR

Soft Grip

75,000 rpm



[OP] Collet chuck ($\phi 2.35\text{mm}, \phi 1/8"$)



No. GT-MG55SR

Ergo Grip

55,000 rpm



No. GT-MG55SAR

Soft Grip

55,000 rpm



[OP] Collet chuck ($\phi 2.35\text{mm}, \phi 1/8"$)



No. GT-MG55S

55,000 rpm



No. GT-MG35-12CC

Soft Grip

35,000 rpm



[OP] Collet chuck ($\phi 2.35\text{mm}, \phi 1/8"$)



[OP] Corner attachment
No. GT-MG25-12CF (Smooth grinding / polishing at 25,000 rpm)
No. GT-MG25-12CC (Precision grinding at 25,000 rpm)

Collet chuck $\phi 6\text{mm}$ High rotation speed and minimum core deviation, realizing an effortless and smooth grinding performance

No. GT-MG25S

25,000 rpm



[OP] Collet chuck ($\phi 3\text{mm}, \phi 1/4", \phi 1/8"$)



No. GT-MG35SAR

Soft Grip

35,000 rpm



[OP] Collet chuck ($\phi 3\text{mm}, \phi 1/4", \phi 1/8"$)



Model No.	No Load Speed (rpm)	Air Consumption (m ³ /min)	Hose Coupling	Air Hose Inner Dia. (mm)	Overall Length (mm)	Frame Dia. (mm)	Weight (g)	Collet Chuck (ϕ mm)	Accessories			EDP No.
									Chuck handle	Spanner	Oil	
GT-MG75S	75,000	0.16	Rc 1/4	6.35	170	18.5	190	3	●	H9	●	310725
GT-MG75SAR	75,000	0.16	Rc 1/4	6.35	156	20.9	180	3	—	H5,H9	●	310726
GT-MG55SR	55,000	0.16	Rc 1/4	6.35	180	20.5	220	3	●	H9	●	310750
GT-MG55SAR	55,000	0.245	Rc 1/4	6.35	178	24.4	260	3	—	H5,H9	●	310773
GT-MG55S	55,000	0.16	Rc 1/4	6.35	165	17.5	180	3	●	H9	●	310705
GT-MG35-12CC	35,000	0.20	Rc 1/4	6.35	183	24.5	305	3	—	H5,H9	●	310774
GT-MG35-12CR	35,000	0.16	Rc 1/4	6.35	151	20.0	160	3	—	H5,H9	●	310748
GT-MG25S	25,000	0.175	Rc 1/4	6.35	198	30.0	600	6	—	H11,H13	●	310765
GT-MG35SAR	35,000	0.285	Rc 1/4	6.35	182	29.4	435	6	—	H11,H13	●	310772

·Working air pressure: 0.6MPa ·Overall length: Accessories and exhaust hose parts not included. ·Weight: Accessories not included.

·In the main body, a 1.5m air intake hose, exhaust hose and a hose joint are attached. ·With regard to GT-MG55S, MG55SR, MG75S and a 2.35 mm collet chuck is also prepared.

[OP] Can be replaced by user. [OP] Should be replaced at our factory.

No. GT-MG25-12CF

Soft Grip

25,000 rpm



OP Corner attachment
 No.GT-MG35-12CC (Precision grinding at 35,000 rpm)
 No.GT-MG25-12CC (Precision grinding at 25,000 rpm)

No. GT-MG25-9CF

Soft Grip

25,000 rpm



OP Corner attachment
 No.GT-MG25-9CC (Precision grinding at 25,000 rpm)
 No.GT-MG35-9CC (Precision grinding at 35,000 rpm)

Model No.	No Load Speed (rpm)	Air Consumption (ml/min)	Hose Coupling	Air Hose Inner Dia. (mm)	Overall Length (mm)	Frame Dia. (mm)	Weight (g)	Tip tool attachment size	Accessories	EDP No.
GT-MG25-12CF	25,000	0.25	Rc 1/4	6.35	181	24.5	315	M7	·Chuck handle ·Oil ·Rubber holder	310776
GT-MG25-9CF	25,000	0.25	Rc 1/4	6.35	173	24.5	310	M7	·PO-ring (#60·100·150·240 3pcs. each)	310775
GT-MG25-12CR	25,000	0.16	Rc 1/4	6.35	160	20.0	200	M7	#400·600 1pc. each	310762
GT-MG25-9CR	25,000	0.16	Rc 1/4	6.35	143	20.0	200	M7	·Lap ring (#600 1pc.) ·Headcup (#80 1pc.)	310761

·Working air pressure: 0.6MPa ·Overall length: Accessories and exhaust hose parts not included. ·Weight: ·Accessories not included. ·In the main body, a 1.5m air intake hose, exhaust hose and a hose joint are attached.

OP Should be replaced at our factory.

Tip Tools for Smooth Surface Grinding and Polishing

To meet work objectives from the removal of cutter marks when manufacturing metal molding, to the finishing of mirror surfaces

No. HC-80 Headcup



Model No.	Grit #	Inner Ctn.	EDP No.
HC-80	80	10	622205

No. RH-30 Rubber Holder



Model No.	Inner Ctn.	EDP No.
RH-30	10	622305

No. PR PO-Ring



Model No.	Grit #	Inner Ctn.	EDP No.
PR-60	60	100	622005
PR-100	100	100	622007
PR-150	150	100	622009
PR-240	240	100	622011
PR-400	400	100	622013
PR-600	600	100	622015

No. LP Lap Ring



Model No.	Grit #	Inner Ctn.	EDP No.
LP-320	320	30	622105

One point

Corner Attachment Replacement Heads

A selection of corner attachments with differing head shapes and gear ratios is available. VESSEL will replace the micro grinder heads in accordance with your needs.

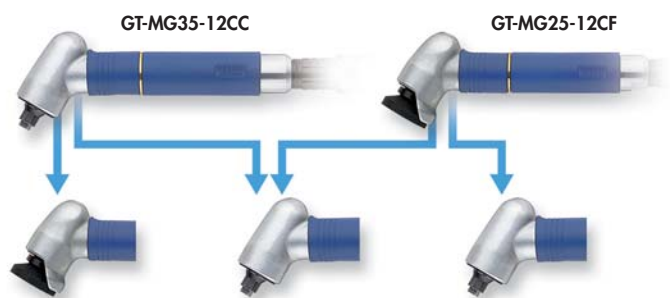

- GT-MG25-12CF**
 ●No Load Speed 25,000rpm
 ●Tip tool attachment size: M7
- GT-MG25-12CC**
 ●No Load Speed 25,000rpm
 ●Collet chuck: φ3mm I.D.
- GT-MG35-12CC**
 ●No Load Speed 35,000rpm
 ●Collet chuck: φ3mm I.D.

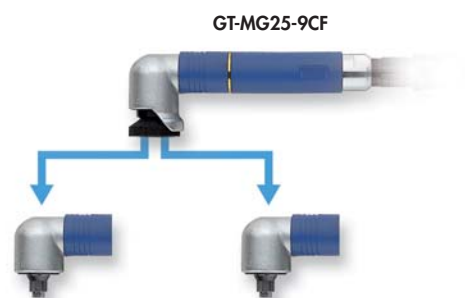

- GT-MG25-9CC**
 ●No Load Speed 25,000rpm
 ●Collet chuck: φ3mm I.D.
- GT-MG35-9CC**
 ●No Load Speed 35,000rpm
 ●Collet chuck: φ3mm I.D.

HAND TOOLS

BITS & SOCKETS

ELECTRIC TOOLS

AIR TOOLS

STATIC SOLUTIONS

GASOLINE ENGINE TOOLS

No. GT-ASC5 Air Scraper



Featuring superior speed, operating efficiency, and durability, our air grinders are designed for cutting sheet, plate, and board material, these air scrapers are available in 2 models, with emphasis on high speed and strength.

The movement amplitude is both exact and strong, and as air scrapers these units have become the focus of attention in the recycling industry.



**No. GT-ASC5
Air Scraper**

Speedy cutting performance with an excellent amplitude balance. User-friendly ergonomic design.

Cutting Capacity Metal Sheet **4mm** Compact and lightweight.

Easy recovery by the restart button in case of unexpected stop.



No. **GT-AS10** PAT.

Noise reducer

Accessories

Blade : 32-tooth thick blade ASB-32H...1pc.
24-tooth thick blade ASB-24H...1pc.

Cutting Capacity Metal Sheet **1.6mm** Compact and lightweight.



No. **GT-AS100** PAT.

Accessories

Blade : 32-tooth standard blade ASB-32...2pcs.

Model No.	Cutting Capacity	Working Air Pressure (MPa)	Stroke Speed (c.p.m.)	Air Consumption (m ³ /min)	Stroke (mm)	Hose Coupling	Overall Length (mm)	Weight (g)	Accessories		EDP No.
									Plug	L-wrench	
GT-AS10	Metal sheet...4mm	0.6	5,000	0.28	10	Rc 1/4	195.5	870	BPB-2	H3	336131
GT-AS100	Metal sheet...1.6mm	0.6	10,000	0.34	10	Rc 1/4	170	570	BPB-2	H2,H4	310640

Cutting capacity: GT-AS10: When used with a No.ABS-32H blade GT-AS100: When used with a No.ASB-32 blade Overall Length and Weight: Accessories not included.

Air Saw Blades(For GT-AS10/AS100)



Model No.	Specifications	Use	Quantity	EDP No.
ASB-32	For steel Cobalt mix, standard blade, 32 teeth	Cutting steel	10	350054
ASB-32H	For steel Cobalt mix, super thick blade, 32 teeth	Cutting plain and stainless steel sheet	10	350052
ASB-24H	For steel Cobalt mix, super thick blade, 24 teeth	Cutting aluminum, soft steel and resin	10	350053
ASC-25-5	Scraper 25 mm wide blade	Scraping, peeling, etc.	1	350143
ASF-F-5	File Flat	File	5	350144
ASF-T-5	File Triangular	File	5	350146

HAND TOOLS

BITS & SOCKETS

ELECTRIC TOOLS

AIR TOOLS

STATIC SOLUTIONS

GASOLINE ENGINE TOOLS

Easy recovery by the restart button in case of unexpected stop.



No. GT-ASC5

Noise reducer
 ※ Scraper sold separately
 ↓ See One point

Model No.	Working Air Pressure (MPa)	Stroke Speed (c.p.m.)	Air Consumption (ml/min)	Stroke (mm)	Hose Coupling	Overall Length (mm)	Weight (g)	Accessories		EDP No.
								Plug	L-wrench	
GT-ASC5	0.6	7,000	0.28	5	Rc 1/4	195.5	810	BPB-2	H3	336132

Scraper(For GT-ASC5)

No. ASC-25-8



No. ASC-50-8



Model No.	Blade Width (mm)	Axis Dia. φ (mm)	Use	EDP No.
ASC-25-8	25	8	for IC chip	350141
ASC-50-8	50	8	for IC chip, wall	350142

One point

Ideal for recycling of automotive and PC



Air Scraper
No. GT-ASC5

Use to detach IC chips from circuit boards when recycling PCs, faxes, copiers.

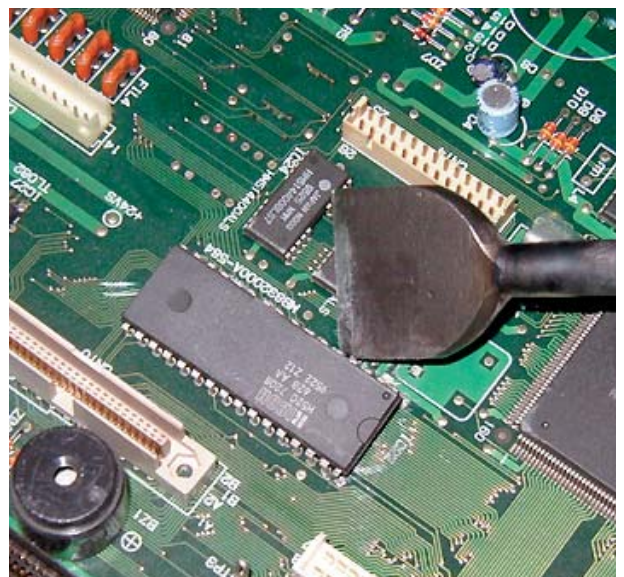

Drill Hole $\phi 6\text{mm}$ Compact and lightweight. Equipped with adjust-valve and silencer, which offer comfort to operators



No. GT-D60-30 NEW

Noise reducer/Rear exhaust



No. GT-D60-45 NEW

Heat protection rubber cover.



Drill Hole $\phi 6\text{mm}$ Suitable for drilling holes on curved surfaces and/or hard-to-work-on places.

Start by pushing



You can use commercially available snake drills.



No. GT-CD60-34 NEW

Air Corner Drill

Rear exhaust

Start with a lever



You can use commercially available snake drills.

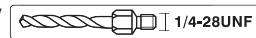

No. GT-CD60-34L NEW

Drill Hole $\phi 8\text{mm}$ Compact, lightweight, and noise reducer equipped, for comfort to the workplace.

No. GT-D80-20

Noise reducer/Rear exhaust



No. GT-D80-20K

Noise reducer/Rear exhaust

Key-less chuck type, which does not need a chuck handle



Drill Hole $\phi 10\text{mm}$ Compact, lightweight, and noise reducer equipped, for comfort to the workplace.

No. GT-D100-15

Noise reducer/Rear exhaust



No. GT-D100-15K

Noise reducer/Rear exhaust

Key-less chuck type, which does not need a chuck handle



Model No.	Steel Plate Drilling Capacity ϕ (mm)	No Load Speed (rpm)	Air Consumption (ml/min)	Hose Coupling	Air Hose Inner Dia. (mm)	Overall Length (mm)	Weight (g)	Chuck Size (mm)	Accessories		EDP No.
									Plug	Chuck handle	
GT-D60-30	6	3,000	0.52	Rc 1/4	6.35	188	880	6.0	BPB-2	Chuck handle	310603
GT-D60-45	6	4,500	0.56	Rc 1/4	6.35	188	890	6.0	BPB-2	Chuck handle	310603
GT-CD60-34	6	3,400	0.42	Rc 1/4	6.35	250	820	6.0	BPB-2	Lock handle, Offset handle, wrench	336141
GT-CD60-34L	6	3,400	0.42	Rc 1/4	6.35	251	840	6.0	BPB-2	Lock handle, Offset handle, wrench	336142
GT-D80-20	8	2,000	0.35	Rc 1/4	6.35	165	940	8.0	BPB-2	Chuck handle	310604
GT-D80-20K	8	2,000	0.35	Rc 1/4	6.35	171	960	8.0	BPB-2	—	310605
GT-D100-15	10	1,500	0.54	Rc 1/4	6.35	189	1,280	10.0	BPB-2	Chuck handle	310606
GT-D100-15K	10	1,500	0.54	Rc 1/4	6.35	195	1,300	10.0	BPB-2	—	310607

*Working air pressure: 0.6MPa *Overall length and Weight: Accessories not included.

HAND TOOLS

BITS & SOCKETS

ELECTRIC TOOLS

AIR TOOLS

STATIC SOLUTIONS

GASOLINE ENGINE TOOLS

No. AD-4 N Air Dusters



2 types are available to meet a variety of needs.

A perfect amalgamation of materials with ergonomic design has made easy-to-use products for all applications of blowing and drying work.



No. AD-4 N
Air Dusters

VESSEL's air dusters boast aluminum die-cast bodies that are light and strong, a wide selection of replaceable nozzles such as extra-long nozzles, flexible nozzles, nozzles with flanges, and a protector to prevent loosening of the handle lever.

Standard Nozzle **AD-4 N** Standard Type.

Flow Volume Adjustment Nozzle **AD-4 J** Can control air flow.



High Volume Nozzle **AD-4 M** Booster nozzle with a higher spraying pressure.
→See 175P One point

Brushing Nozzle **AD-4 B** Powerfully sweeps out particles with a sturdy brush.
→See 175P One point



Long Nozzle **AD-4 N** For working in deep and distant places.

Flexible Nozzle **AD-4 NF** Bendable nozzle.

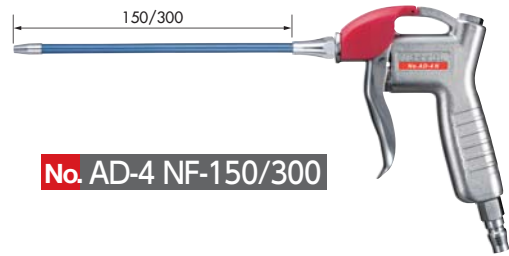
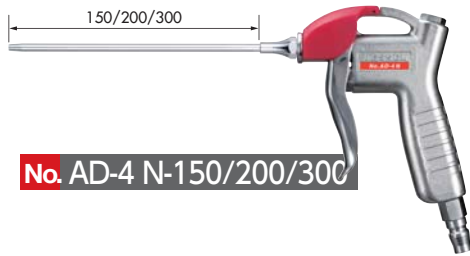

Model No.	Nozzle Type	Nozzle Inner Dia. (mm)	Air Consumption (ℓ/min)	Overall Length (mm)	Weight (g)	Air Hose Connection	Outer Ctn.	Card/ Box Size (mm)	EDP No.
AD-4 N	Standard Nozzle	2	180	125	235	Coupling	20	in paper box 110×173	141180
AD-4 N-PB	Standard Nozzle	2	180	125	235	Coupling	10	185×160	141181
AD-4 N-PT	Standard Nozzle	2	180	125	235	1/4 Hose	10	185×160	141182
AD-4 J	Flow Adjustment Nozzle	2	150	130	240	Coupling	20	in paper box 110×173	141183
AD-4 J-PB	Flow Adjustment Nozzle	2	150	130	240	Coupling	10	185×160	141184
AD-4 J-PT	Flow Adjustment Nozzle	2	150	130	240	1/4 Hose	10	185×160	141185
AD-4 M	High Volume Nozzle	2×1pc,0.8×4pcs.	240	125	228	Coupling	20	in paper box 110×173	141187
AD-4 B	Brushing Nozzle	2	180	170	248	Coupling	10	in paper box 115×220	141186
AD-4 N-150	Long Nozzle	2.5	180	275	248	Coupling	10	in paper box 140×300	141188
AD-4 N-200	Long Nozzle	2.5	180	325	253	Coupling	10	in paper box 140×450	141189
AD-4 N-300	Long Nozzle	2.5	180	425	260	Coupling	10	in paper box 140×450	141190
AD-4 NF-150	Flexible Nozzle ※	2.3	180	275	260	Coupling	10	in paper box 140×300	141191
AD-4 NF-300	Flexible Nozzle ※	2.3	180	425	274	Coupling	10	in paper box 140×450	141193

*Power source: compressed air ·Working air pressure: 0.5MPa ·Max. working pressure: 0.7MPa ·Working temperature range: 0-60°C (32-140°F) ·Working air hose I.D.: φ4mm and more
·Overall length and weight: Air coupler included. ※It can be bent freely due to the built-in copper tube. (Do not bend it at a steep angle.)



Box package



Also compatible with hanging type



Slide package

HAND TOOLS

BITS & SOCKETS

ELECTRIC TOOLS

AIR TOOLS

STATIC SOLUTIONS

GASOLINE ENGINE TOOLS

Interchangeable Nozzles (for AD-4) /Brushes (for AD-4 B)

Long Nozzle

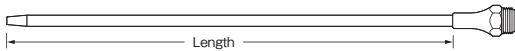

Air Flow Volume Adjustment Long Nozzle

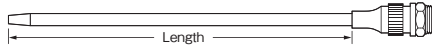

Slender Nozzle Ideal for narrow spaces

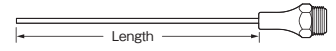

Inlet: G1/8

Flexible Nozzle

Bendable shaft

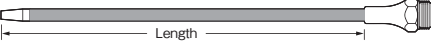

Plastic Nozzle

Safe and dent-free

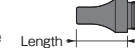

Interchangeable Brush



Long Nozzle

Model No.	Innner Dia.	Outer Dia.	Length (mm)	Inner Ctn.	EDP No.
LN-150	2.5	5	150	10	141133
LN-200	2.5	5	200	10	141134
LN-300	2.5	5	300	10	141135
LN-500	2.5	5	500	10	141136

Air Flow Volume Adjustment Long Nozzle

LJ-150	2.5	5	150	10	141137
LJ-200	2.5	5	200	10	141138
LJ-300	2.5	5	300	10	141139
LJ-500	2.5	5	500	10	141140

Slender Nozzle

LS-2-100	0.9	2	100	10	141141
-----------------	-----	---	-----	----	--------

Flexible Nozzle Shaft

Model No.	Innner Dia.	Outer Dia.	Length (mm)	Inner Ctn.	EDP No.
LF-150	2.3	7	150	10	141143
LF-200	2.3	7	200	10	141144
LF-300	2.3	7	300	10	141145
LF-700	2.3	7	700	10	141146

Plastic Nozzle

SP-0	2.0	7.5	21	1	141132
-------------	-----	-----	----	---	--------

Interchangeable Brush

Model No.	Brush Length	Outer Dia.	Length (mm)	Inner Ctn.	EDP No.
SB-50	60	35	68	5	141147

One point

Powerful brushing performance with a sturdy brush
Brushing Nozzle

Securely brush off oil-soaked chips and shavings which cannot be blown off by air.

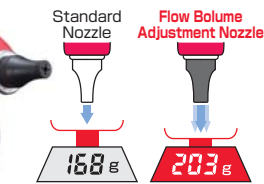
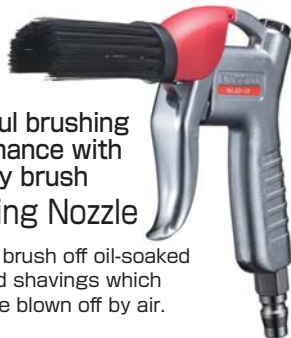

Increased blowing power
High Volume Nozzle

Thrust force increased by 20% compared with the standard nozzle. Booster nozzle has a great wind pressure to powerfully blow off chips and shavings stuck in narrow gaps in chuck claws and cutter trench.

Standard Nozzle **AD-2** To blow off machined chips, moisture, and oil

No. AD-2 0N



No. AD-2 0N-PB



Long Nozzle **AD-2 100N/ 200N/ 300N** To blow off machined chips, moisture, and oil

No. AD-2 100N



No. AD-2 100N-PB



No. AD-2 200N/300N

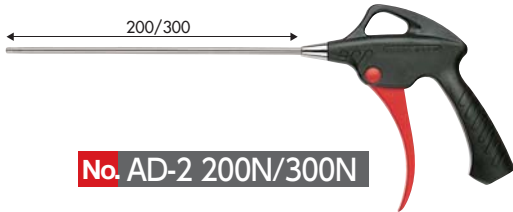

25° Long Nozzle **AD-2 100A** 25° bendable tip to improve workability

No. AD-2 100A

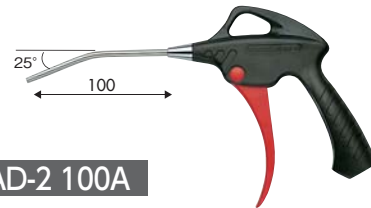

Safety Bypass Nozzle **AD-2 0S** To blow off safely and quietly in a wide area

No. AD-2 0S



Safety Bypass Long Nozzle **AD-2 100S** To blow off safely and quietly in a wide area

No. AD-2 100S

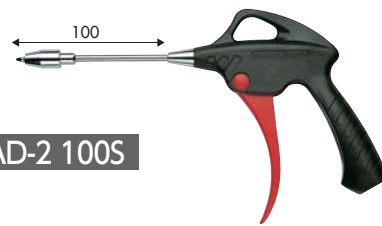

Large finger throttle lever for less fatigue to control the air volume. The ergonomically designed handle enables outstanding operability. Dust removal and drying of sheet metal, coated materials, automotive parts, molds, metal working, etc.

Model No.	Nozzle Type	Nozzle		Air Consumption (ℓ/min)	Overall Length (mm)	Weight (g)	Outer Ctn.	Card/ Box Size (mm)	EDP No.
		Length	Inner Dia.(mm)						
AD-2 0N	Standard Nozzle	0	2.1	135	145	122	10	152×232	141111
AD-2 0N-PB	Standard Nozzle (with plug)	0	2.1	135	155	146	10	152×232	141151
AD-2 100N	Long Nozzle	100	2.1	135	242	131	10	182×232	141112
AD-2 100N-PB	Long Nozzle (with plug)	100	2.1	135	252	157	10	182×232	141152
AD-2 200N	Long Nozzle	200	2.1	135	342	141	1	in paper box 140×445	141113
AD-2 300N	Long Nozzle	300	2.1	135	442	150	1	in paper box 140×455	141114
AD-2 100A	25° Long Nozzle	100	2.1	135	242	131	10	182×232	141115
AD-2 0S	Safety Bypass nozzle	0	2.1	105	155.5	131	10	152×232	141121
AD-2 100S	Safety Bypass long nozzle	100	2.1	105	239.5	151	10	182×232	141122

·Power source: compressed air ·Max. working pressure: 0.97MPa ·Working temperature range: 0-60°C (32-140°F) ·Air inlet screw diameter: Rc 1/4
 ·Working air hose I.D.: φ4mm and more ·Air pressure when air consumption is measured: 0.49MPa ·Pre-packed (200N, 300N in paper box)

※Nozzle can not be replaced.

HAND TOOLS

BITS & SOCKETS

ELECTRIC TOOLS

AIR TOOLS

STATIC SOLUTIONS

GASOLINE ENGINE TOOLS

Rubber Nozzle **AD-2 0R** Dust blow off, not making scratches on a part

Rubber Long Nozzle **AD-2 100R** Dust blow off, not making scratches on a part



Nozzle with soft rubber tip.

No. AD-2 0R

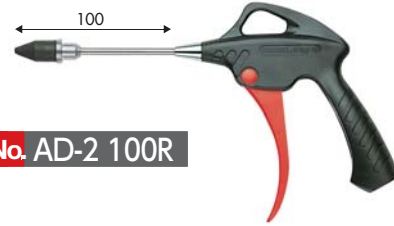

No. AD-2 100R

High Volume Nozzle **AD-2 0M** When more air volume is required in spite of low air pressure

Air flow booster type.
Venturi nozzle emits air to wider area.
2.5 times more emission than AD-2 0N type.



No. AD-2 0M

Chip Shield Long Nozzle **AD-2 100P** Plastic plate prevents dust and particles from blowing back and scattering

Ideal for blowing out dust from a narrow hole or deep place.

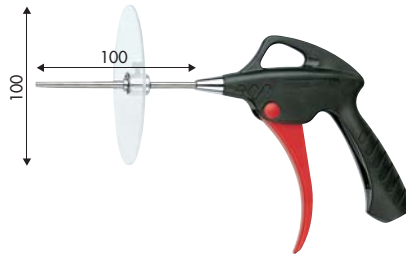
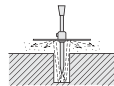

No. AD-2 100P



Blister package

Air Screen Nozzle **AD-2 0C** Air curtain prevents dust and particles from blowing back and scattering

Air curtain shuts out the spreading of oil, moisture and cutting dust.

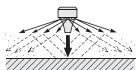

No. AD-2 0C



Box package

Large finger throttle lever for less fatigue to control the air volume. The ergonomically designed handle enables outstanding operability. Dust removal and drying of sheet metal, coated materials, automotive parts, molds, metal working.

Model No.	Nozzle Shape	Nozzle		Air Consumption (ℓ/min)	Overall Length (mm)	Weight (g)	Outer Ctn.	Card/ Box Size (mm)	EDP No.
		Length	Inner Dia. (mm)						
AD-2 0R	Rubber Nozzle	0	2.1	115	155.5	123	10	152×232	141116
AD-2 100R	Rubber Long Nozzle	100	2.1	115	227	147	10	182×232	141117
AD-2 0M	High Volume Nozzle	0	10	185	160	126	10	152×232	141118
AD-2 100P	Chip Shield Long Nozzle	100	2.1	135	242	157	10	182×232	141120
AD-2 0C	Air Screen Nozzle	0	2.8	260	145	127	10	152×232	141119

·Power source: compressed air ·Max. working pressure: 0.97MPa ·Working temperature range: 0-60°C (32-140°F) ·Air inlet screw diameter: Rc 1/4
·Working air hose I.D.: φ4mm and more ·Air pressure when air consumption is measured: 0.49MPa ·Pre-packed

※Nozzle can not be replaced.