

HAND TOOLS





Contents

- Cushion Grip Screwdrivers 8 - 12
- MEGADORA Series 13 - 15
- Plastic Grip Screwdrivers 16 - 20
- Eco-friendly Screwdriver 21 - 23
- Wooden Handle Screwdrivers 24 - 25
- Non-Slip Screwdriver 26 - 28
- Precision Screwdrivers 29 - 31
- Functional Screwdrivers 32 - 39
- Torque Screwdriver 40 - 41
- Hex Wrenches / TORX Wrench 42 - 47
- For particular job unique tools 48 - 51

HAND TOOLS
BITS & SOCKETS
ELECTRIC TOOLS
AIR TOOLS
STATIC SOLUTIONS
GASOLINE ENGINE TOOLS

About ISO

ISO 9001 : 2008

Our screwdriver manufacturing division, VESSEL SHIMANE CO., LTD is certified according to ISO standard, the global standard for quality assurance control.



ISO 14001 : 2004

We obtained ISO 14001 in August 2010. VESSEL will further strive to offer eco-friendly products, aiming at minimizing the environmental burden as a manufacturing group.



HAND TOOLS TECHNICAL

HAND TOOLS

BITS & SOCKETS

ELECTRIC TOOLS

AIR TOOLS

STATIC SOLUTIONS

GASOLINE ENGINE TOOLS

Nominal designation based on shank types

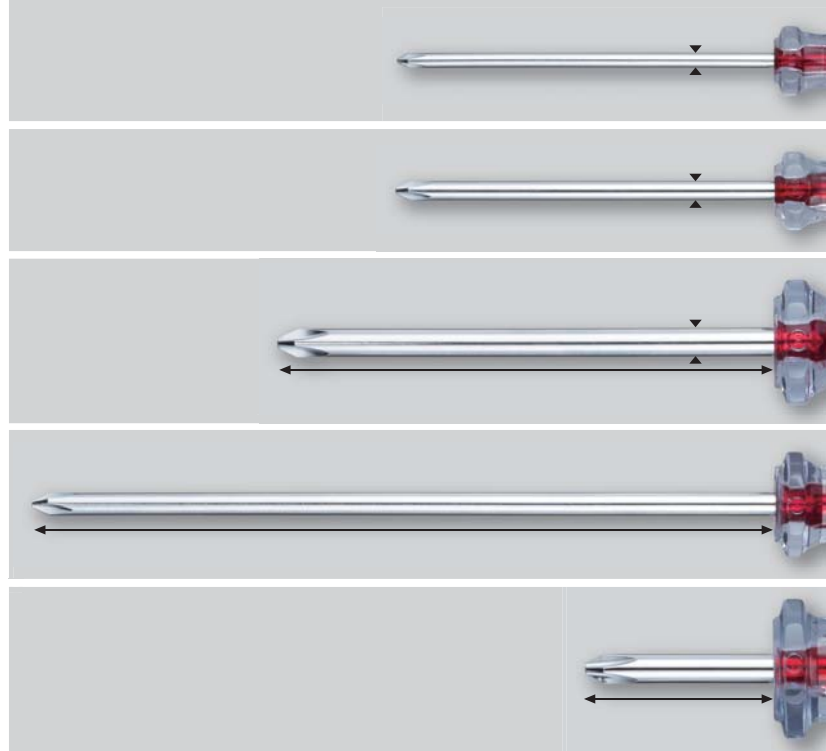

Cr-V steel
Cr-V Mo steel

Good precision and durability nurtured in assembly lines Chrome vanadium steel that improves the shank strength

Cr (chromium): hardens the tip.
V (vanadium): makes the tip tough.
MO (molybdenum): improves strength, hardness, and even toughness.

Precision shank A shank diameter of 3 mm or less

This is for precision small screws whose thread diameter is 1 to 3 mm.

Slim shank A diameter of 4 mm

This is a long slender shank to avoid interference even in a narrow area.

Standard shank

It has a popular shank diameter and length based on various standards.

Long shank

This is suitable for screw tightening in deep and narrow areas.

Stubby shank

This is a short shank suitable for work in a confined area.

Hexagon bolster

This part allows a spanner, etc. to be applied to retighten a screw or undo a hard-tightened screw.

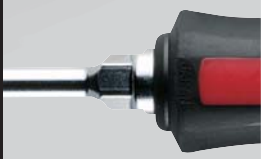

Magnetized Tip-End

The tip-end is strongly magnetized to capture screws for better work efficiency.



JAWSFIT®

NEW JAWSFIT

Coated specially with high strength metallic granules. This prevents CAM-OUT (phenomenon peculiar to cross recessed screws).

Black point®

The tip-end with the black oxide finishment is insensitive to the effect of a plating layer thickness and highly precise.





General type

Type in which a shank is held in the handle. It is electrically safe.



Tang-thru type

A shank is installed through the handle so that the screwdriver can be used for position adjustment or screw-hole correction by tapping the head with a hammer.



CAUTION

Safety icons are printed and indicated for easy identification.

(Displayed in a stepwise manner on a product basis)



Cushion

An elastomer is integrally formed on the exterior of the grip. It provides elastic grip, offering large tightening force.

8P

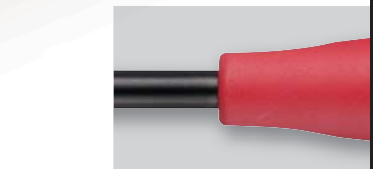

Taper shape

Enabling a screwdriver to be easily taken out of a screwdriver holder. It is often used for screwdrivers related to electrical equipment.



Rolling prevention

Having a shape avoiding rolling over, which has also been widely adopted by overseas screwdrivers.



Ergonomics design

The use of design taking into account the shape of the palm and enhancing the operability at the finger tips ensures comfortable screw tightening.

13P
16P
21P

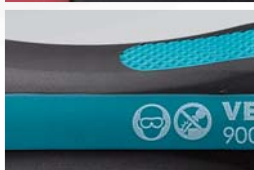

Wood handle

A long seller grip made of air-dried natural wood. It fits the palm of the hand as the tool is used longer.

24P



Non-slip

VESSEL-developed non-slip surface features fine knurling process, enabling torque to be transmitted firmly even if there is oil on it.

26P

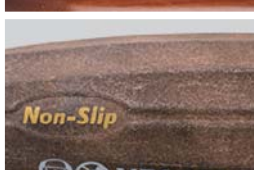

Precision use

Designed to transmit a minute force efficiently. Intended for precision work

29P



Other functional grips

A ratchet screwdriver allowing screw tightening to be made by mere repetition of wrist movement; an impact screwdriver used to undo a rusted or stuck screw, etc.

32P



Environmental measures

Pb (lead), Cd (cadmium), Hg (mercury), hexavalent chromium, PBB (polybrominated biphenyl), and PBDE (polybrominated diphenyl ether)

This symbol indicates the products that conform to VESSEL's environment measure standards compliant with the restriction of the use of certain hazardous substances (six substances listed above) (RoHS directive).

No. 700

Super Cushion Screwdriver



Highly elastic cushion grip.
Fits the palm of the hand. No slipping.
Transmits high torque to the tip.



A D V A N C E D
GEL-FUNCTION
T E C H N O L O G Y

No. 700
Super Cushion
Screwdriver

VESSEL Cushion Grip Screwdrivers fit not only screw heads but also your hand. This series assure the efficient torque transmission.

※The photograph is an image.

HAND TOOLS

BITS & SOCKETS

ELECTRIC TOOLS

AIR TOOLS

STATIC SOLUTIONS

GASOLINE ENGINE TOOLS

No. 700 Super Cushion Screwdriver PAT.

- "Super Cushion" grip fits your hand perfectly.
- Rust-resistant black chrome plating.



| No.700 | Bit | | Bit (mm) | | | | Inner Ctn. | Outer Ctn. | EDP No. |
|------------|-------|-----|----------|-----|-----|-----|------------|------------|---------|
| ⊖ 5.5 × 75 | 5.5 | 0.8 | 75 | 5.5 | 29 | 182 | 6 | 120 | 125211 |
| ⊖ 6 × 100 | 6.0 | 0.9 | 100 | 6.4 | 32 | 215 | 6 | 120 | 125212 |
| ⊖ 6 × 150 | 6.0 | 0.9 | 150 | 6.4 | 32 | 265 | 6 | 120 | 125213 |
| ⊖ 8 × 150 | 8.0 | 1.1 | 150 | 8.0 | 34 | 275 | 6 | 120 | 125214 |
| ⊕ 1 × 75 | ⊕No.1 | 75 | 5.5 | 29 | 182 | | 6 | 120 | 125215 |
| ⊕ 2 × 100 | ⊕No.2 | 100 | 6.4 | 32 | 215 | | 6 | 120 | 125216 |
| ⊕ 2 × 150 | ⊕No.2 | 150 | 6.4 | 32 | 265 | | 6 | 120 | 125217 |
| ⊕ 3 × 150 | ⊕No.3 | 150 | 8.0 | 34 | 275 | | 6 | 120 | 125218 |

No. 720 Super Cushion Screwdriver (Stubby Type) PAT.

- "Super Cushion" grip fits your hand perfectly.
- Rust-resistant black chrome plating.
- Ideal for working in cramped places.



| No.720 | Bit | | Bit (mm) | | | | Inner Ctn. | Outer Ctn. | EDP No. |
|----------|-------|-----|----------|-----|----|----|------------|------------|---------|
| ⊖ 6 × 15 | 6.0 | 0.9 | 15 | 6.0 | 35 | 68 | 6 | 120 | 125221 |
| ⊕ 1 × 15 | ⊕No.1 | 15 | 6.0 | 35 | 68 | | 6 | 120 | 125222 |
| ⊕ 2 × 15 | ⊕No.2 | 15 | 6.0 | 35 | 68 | | 6 | 120 | 125223 |

No. 730 Super Cushion Tang-Thru Screwdriver PAT.

- "Super Cushion" grip fits your hand perfectly.
- Tang-thru type with a star-shaped end cap for hammering.
- Rust-resistant black chrome plating.



| No.730 | Bit | | Bit (mm) | | | | Inner Ctn. | Outer Ctn. | EDP No. |
|------------|-------|-----|----------|-----|-----|-----|------------|------------|---------|
| ⊖ 5.5 × 75 | 5.5 | 0.8 | 75 | 5.5 | 29 | 182 | 6 | 120 | 125231 |
| ⊖ 6 × 100 | 6.0 | 0.9 | 100 | 6.4 | 32 | 215 | 6 | 120 | 125232 |
| ⊖ 6 × 150 | 6.0 | 0.9 | 150 | 6.4 | 32 | 265 | 6 | 120 | 125233 |
| ⊖ 8 × 150 | 8.0 | 1.1 | 150 | 8.0 | 34 | 276 | 6 | 60 | 125234 |
| ⊕ 1 × 75 | ⊕No.1 | 75 | 5.5 | 29 | 182 | | 6 | 120 | 125235 |
| ⊕ 2 × 100 | ⊕No.2 | 100 | 6.4 | 32 | 215 | | 6 | 120 | 125236 |
| ⊕ 2 × 150 | ⊕No.2 | 150 | 6.4 | 32 | 265 | | 6 | 120 | 125237 |
| ⊕ 3 × 150 | ⊕No.3 | 150 | 8.0 | 34 | 276 | | 6 | 60 | 125238 |

No. 610 Cushion Grip Screwdriver (Thin Shank Type)

- Ideal for screw tightening in precision fields.
- Straight cut slotted tip good even for a use in cramped spaces.
- Highly precise black point tip, not being affected by the thickness of the plating layer.



| No.610 | Bit | | Bit (mm) | | | | Inner Ctn. | Outer Ctn. | EDP No. |
|-----------|--------|-----|----------|------|------|-----|------------|------------|---------|
| ⊖ 4 × 75 | 4.0 | 0.5 | 75 | 4.0 | 20.5 | 162 | 12 | 120 | 125332 |
| ⊖ 4 × 100 | 4.0 | 0.5 | 100 | 4.0 | 20.5 | 187 | 12 | 120 | 125333 |
| ⊖ 4 × 150 | 4.0 | 0.5 | 150 | 4.0 | 20.5 | 237 | 12 | 120 | 125335 |
| ⊖ 4 × 200 | 4.0 | 0.5 | 200 | 4.0 | 20.5 | 287 | 12 | 120 | 125336 |
| ⊕ 00 × 75 | ⊕No.00 | 75 | 4.0 | 20.5 | 162 | | 12 | 120 | 125337 |
| ⊕ 0 × 75 | ⊕No.0 | 75 | 4.0 | 20.5 | 162 | | 12 | 120 | 125339 |
| ⊕ 0 × 100 | ⊕No.0 | 100 | 4.0 | 20.5 | 187 | | 12 | 120 | 125340 |
| ⊕ 1 × 75 | ⊕No.1 | 75 | 4.0 | 20.5 | 162 | | 12 | 120 | 125341 |
| ⊕ 1 × 100 | ⊕No.1 | 100 | 4.0 | 20.5 | 187 | | 12 | 120 | 125342 |
| ⊕ 1 × 150 | ⊕No.1 | 150 | 4.0 | 20.5 | 237 | | 12 | 120 | 125343 |

No. 660 Cushion Grip Screwdriver (Stubby Type)

- With reversible blade (⊖5, ⊕2).

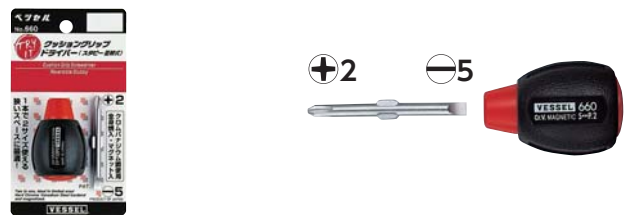

| Set content | | Package size (mm) | Inner Ctn. | Outer Ctn. | EDP No. |
|------------------|-----------------------|-------------------|------------|------------|---------|
| Grip | length 53mm dia. 35mm | 135×75×35 | 10 | 60 | 133085 |
| Reversible blade | ⊖5 / ⊕2 ×60mm 1pc | | | | |

No. TD-110 Cushion 4-way Stubby Screwdriver

- Handle can store 2 types of double-ended bit with different tip end.

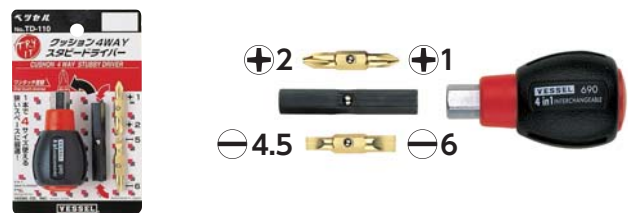

| Set content | | Package size (mm) | Inner Ctn. | Outer Ctn. | EDP No. |
|------------------|-----------------------|-------------------|------------|------------|---------|
| Grip | length 86mm dia. 35mm | 135×85×35 | 10 | 60 | 251110 |
| Reversible blade | ⊕1 / ⊕2 ×35mm 1pc | | | | |
| Holder | ⊖4.5 / ⊖6 ×35mm 1pc | | | | |

No. 220 Ball-Grip Screwdriver

- Transmits ample tightening force to screw.
- Cushion grip color-coded by ⊕⊖.
- High precision black point tip.

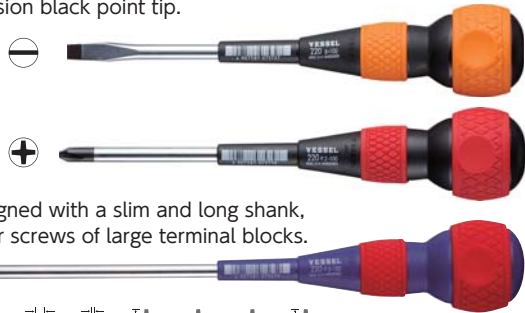

- ⊕3 is designed with a slim and long shank, optimal for screws of large terminal blocks.



| No.220 | Inner Ctn. | Outer Ctn. | EDP No. | |
|-------------|------------|------------|----------------|-------------|
| ⊖ 5.5 × 75 | 5.5 | 0.8 | 75 5.5 32 156 | 6 60 125351 |
| ⊖ 5.5 × 100 | 5.5 | 0.8 | 100 5.5 32 181 | 6 60 125361 |
| ⊖ 5.5 × 150 | 5.5 | 0.8 | 150 5.5 32 231 | 6 60 125362 |
| ⊖ 6 × 100 | 6.0 | 0.9 | 100 6.4 41 200 | 6 60 125352 |
| ⊖ 6 × 150 | 6.0 | 0.9 | 150 6.4 41 250 | 6 60 125353 |
| ⊖ 6 × 200 | 6.0 | 0.9 | 200 6.4 41 300 | 6 60 125354 |
| ⊕ 1 × 75 | ⊕No.1 | 75 | 5.5 32 156 | 6 60 125355 |
| ⊕ 1 × 100 | ⊕No.1 | 100 | 5.5 32 181 | 6 60 125371 |
| ⊕ 1 × 150 | ⊕No.1 | 150 | 5.5 32 231 | 6 60 125372 |
| ⊕ 2 × 100 | ⊕No.2 | 100 | 6.4 41 200 | 6 60 125356 |
| ⊕ 2 × 150 | ⊕No.2 | 150 | 6.4 41 250 | 6 60 125357 |
| ⊕ 2 × 200 | ⊕No.2 | 200 | 6.4 41 300 | 6 60 125358 |
| ⊕ 3 × 150 | ⊕No.3 | 150 | 6.4 41 250 | 6 60 125374 |

No. 220F Free-Turning Ball Grip Screwdriver (Screwdriver only)

PAT.

- Free-turning hook enables fast turning.
- Elastomer resin excellently fits the hand.

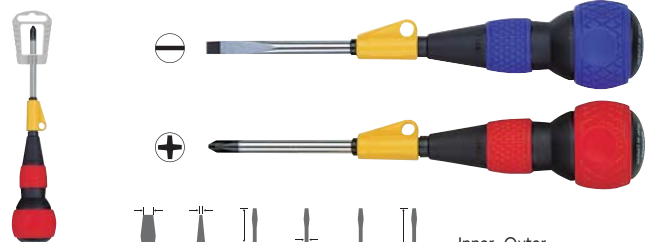

| No.220F | Inner Ctn. | Outer Ctn. | EDP No. | |
|-----------|------------|------------|----------------|-------------|
| ⊖ 6 × 100 | 6.0 | 0.9 | 100 6.4 41 200 | 6 60 125541 |
| ⊖ 6 × 150 | 6.0 | 0.9 | 150 6.4 41 250 | 6 60 125542 |
| ⊕ 2 × 100 | ⊕No.2 | 100 | 6.4 41 200 | 6 60 125543 |
| ⊕ 2 × 150 | ⊕No.2 | 150 | 6.4 41 250 | 6 60 125544 |

No. B-640TX Cushion Grip TORX Screwdriver NEW

- Optimal for fastening screws in precision fields.
- Non-electrolytic plating, keeping the precise tip quality.
- Cushion grip fitting comfortably in a hand.
- Also good for tamper-proof TORX screws (except T5 and T6).



| No.B-640TX | Inner Ctn. | Outer Ctn. | EDP No. | |
|------------|------------|------------|--------------|-------------|
| T5 | 1.42 | 40 | 4.0 20.5 126 | 6 60 123561 |
| T6 | 1.69 | 40 | 4.0 20.5 126 | 6 60 123562 |
| T7H | 1.97 | 40 | 4.0 20.5 126 | 6 60 123563 |
| T8H | 2.30 | 40 | 4.0 20.5 126 | 6 60 123564 |
| T9H | 2.48 | 40 | 4.0 20.5 126 | 6 60 123565 |

TORX® is a registered trademark of Acument TM Intellectual Properties, LLC (USA). VESSEL has a manufacturing license in Japan and selling same to the world.

No. 230 Ball-Grip Tang-Thru Screwdriver

- Tang-Thru shank with star end cap.
- Transmits ample tightening force to screw.
- Cushion grip color-coded by ⊕⊖.
- High precision black point tip.



| No.230 | Inner Ctn. | Outer Ctn. | EDP No. | |
|------------|------------|------------|----------------|-------------|
| ⊖ 5.5 × 75 | 5.5 | 0.8 | 75 5.5 32 156 | 6 60 125311 |
| ⊖ 6 × 100 | 6.0 | 0.9 | 100 6.4 41 200 | 6 60 125314 |
| ⊖ 6 × 150 | 6.0 | 0.9 | 150 6.4 41 250 | 6 60 125315 |
| ⊕ 1 × 75 | ⊕No.1 | 75 | 5.5 32 156 | 6 60 125321 |
| ⊕ 2 × 100 | ⊕No.2 | 100 | 6.4 41 200 | 6 60 125324 |
| ⊕ 2 × 150 | ⊕No.2 | 150 | 6.4 41 250 | 6 60 125325 |

No. 225 Ball-Grip Screwdriver (With covered shank)

- Resin-covered shank. It prevents electrical short circuit.
- Transmits ample tightening force to screw.
- Cushion grip is marked ⊕⊖ for quick identification.

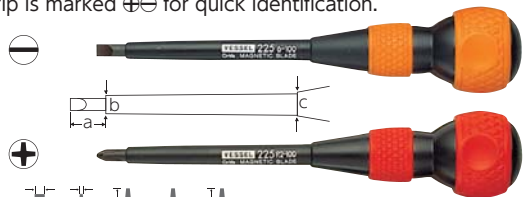

| No.225 | Inner Ctn. | Outer Ctn. | EDP No. | |
|-----------|------------|------------|--------------------|-------------|
| ⊖ 6 × 100 | 6.0 | 0.9 | 100 41 200 14 8 10 | 6 60 125382 |
| ⊖ 6 × 150 | 6.0 | 0.9 | 150 41 250 14 8 10 | 6 60 125383 |
| ⊕ 2 × 100 | ⊕No.2 | 100 | 41 200 14 8 10 | 6 60 125389 |
| ⊕ 2 × 150 | ⊕No.2 | 150 | 41 250 14 8 10 | 6 60 125390 |

⚠ Electric insulation is not guaranteed. For safety purposes, shut off power before use. The covered shaft protects against unexpected shorts. Should it become scratched, damaged or deteriorated, do not use the screwdriver.

No. 265 "NEON" Screwdriver

- Glow-in-the-dark type.
- High precision black point tip.

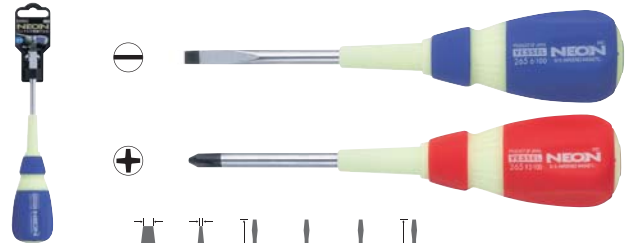

| No.265 | Inner Ctn. | Outer Ctn. | EDP No. | |
|-----------|------------|------------|----------------|-------------|
| ⊖ 6 × 100 | 6.0 | 0.9 | 100 6.4 40 185 | 6 60 125561 |
| ⊖ 6 × 150 | 6.0 | 0.9 | 150 6.4 40 235 | 6 60 125562 |
| ⊕ 2 × 100 | ⊕No.2 | 100 | 6.4 40 185 | 6 60 125563 |
| ⊕ 2 × 150 | ⊕No.2 | 150 | 6.4 40 235 | 6 60 125564 |

HAND TOOLS

BITS & SOCKETS

ELECTRIC TOOLS

AIR TOOLS

STATIC SOLUTIONS

GASOLINE ENGINE TOOLS

No. 250 Tang-Thru Screwdriver w/Ceramic Ball (For electric works)

- Incorporates a ceramic ball preventing electricity from being conducted.
- Uses zirconia ceramics having the highest rigidity and wear resistance among ceramics.
- Easy to tap with a hammer on the large nut.
- High-precision black point tip.



| No.250 | | | | | | | Inner Ctn. | Outer Ctn. | EDP No. |
|-----------|-------|-----|-----|-----|----|-----|------------|------------|---------|
| ⊖ 6 × 100 | 6.0 | 0.9 | 100 | 6.4 | 41 | 200 | 6 | 60 | 112105 |
| ⊖ 6 × 150 | 6.0 | 0.9 | 150 | 6.4 | 41 | 250 | 6 | 60 | 112106 |
| ⊕ 2 × 100 | ⊕No.2 | | 100 | 6.4 | 41 | 200 | 6 | 60 | 112107 |
| ⊕ 2 × 150 | ⊕No.2 | | 150 | 6.4 | 41 | 250 | 6 | 60 | 112108 |

One point

Tang-thru screwdriver No. 250 that incorporates a ceramic ball preventing electricity from being conducted

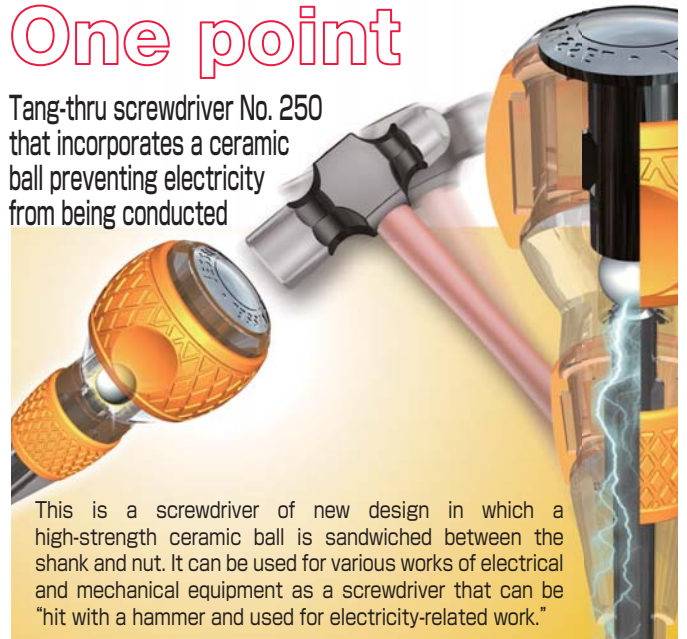

This is a screwdriver of new design in which a high-strength ceramic ball is sandwiched between the shank and nut. It can be used for various works of electrical and mechanical equipment as a screwdriver that can be "hit with a hammer and used for electricity-related work."

⚠ Electric insulation is not guaranteed. For safety purposes, shut off power before use.

No. 220W Ball Grip (Bit-replaceable grip)

- Compatibility with a 6.35mm hex drive bit enables to be used as a familiar ball grip screwdriver.



| Model No. | Grip size | Package size (mm) | Outer Ctn. | EDP No. |
|-----------|------------------------|-------------------|------------|---------|
| 220W | length 100mm, dia.41mm | 145×50×43 | 10 | 125344 |

No. 230W Ball Grip (Bit-replaceable Tang-Thru grip) NEW

- Blade interchangeable tang-thru grip. (A/F6.35mm)
- 25mm large nut incorporated transmitting well the hammering power.



| Model No. | Grip size | Package size (mm) | Inner Ctn. | EDP No. |
|-----------|------------------------|-------------------|------------|---------|
| 230W | length 100mm, dia.41mm | 145×50×43 | 10 | 125326 |

No. 270BW Cushion Stubby (Bit-replaceable grip)

- Stubby type optimal for a narrow area. Compatibility with a 6.35mm hex drive bit for electric screwdrivers.



| Model No. | Grip size | Package size (mm) | Outer Ctn. | EDP No. |
|-----------|-------------------------|-------------------|------------|---------|
| 270BW | length 55.5mm, dia.35mm | 100×50×37 | 10 | 233074 |

One point

Features of replacement grip

This is a screwdriver grip enabling a electric driver bit of a hexagonal width-across-flats of 6.35 mm to be inserted and used.



No. 210 Ball Grip Screwdriver (for electric works) NEW

- 125mm long shank is good for screw-tightening even deep in distribution boards and ideal for not contacting the floor when squatting.
- High-precision black point tip.



| No.210 | | Bit (mm) | | | | | | Inner Ctn. | Outer Ctn. | EDP No. |
|--------|-----|----------|-----|-----|-----|-----|-----|------------|------------|---------|
| ⊖ 6× | 125 | 6.0 | 0.9 | 125 | 6.4 | 41 | 225 | 6 | 60 | 125575 |
| ⊕ 2× | 125 | ⊕No.2 | 125 | 6.4 | 41 | 225 | 6 | 60 | 125574 | |

No. 2200 Ball Ratchet Screwdriver NEW

- With 36-teeth gear ratchet to realize comfortable operation with fine tuning.
- Shank cover prevents short circuits. Thin shank is convenient for operating on terminal blocks.
- Shank uses bit materials, fully hardened. Replacement shank is available as option.



| No.2200 | | Bit (mm) | | | | | | Inner Ctn. | Outer Ctn. | EDP No. |
|---------|-----|----------|-----|-----|-----|-----|-----|------------|------------|---------|
| ⊖ 6× | 100 | 6.0 | 0.8 | 100 | 6.0 | 41 | 200 | 6 | 60 | 125395 |
| ⊖ 6× | 150 | 6.0 | 0.8 | 150 | 6.0 | 41 | 250 | 6 | 60 | 125396 |
| ⊕ 2× | 100 | ⊕No.2 | 100 | 6.0 | 41 | 200 | 6 | 60 | 125345 | |
| ⊕ 2× | 150 | ⊕No.2 | 150 | 6.0 | 41 | 250 | 6 | 60 | 125346 | |
| ⊕ 3× | 150 | ⊕No.3 | 150 | 6.0 | 41 | 250 | 6 | 60 | 125347 | |

⚠ Electric insulation is not guaranteed. For safety purposes, shut off power before use.

No. 210ST Slim Free-Turning Ball Grip Screwdriver (for electric works) NEW

- 125mm long shank is good for screw-tightening even deep in distribution boards and ideal for not contacting the floor when squatting.
- Provided with a slim free-turning part, which enables fast turning and smooth on/off from the screwdriver holder.

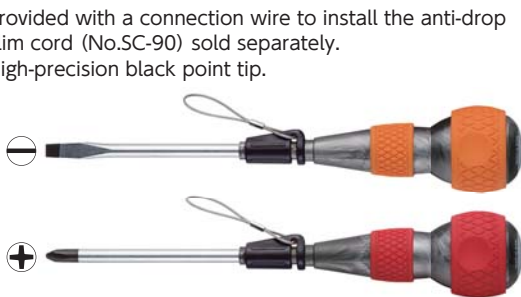

| No.210ST | | Bit (mm) | | | | | | Inner Ctn. | Outer Ctn. | EDP No. |
|----------|-----|----------|-----|-----|-----|-----|-----|------------|------------|---------|
| ⊖ 6× | 125 | 6.0 | 0.9 | 125 | 6.4 | 41 | 225 | 6 | 60 | 125577 |
| ⊕ 2× | 125 | ⊕No.2 | 125 | 6.4 | 41 | 225 | 6 | 60 | 125576 | |

No. 2200B Ball Ratchet Screwdriver Reversible Blade NEW

- Shank uses bit materials, fully hardened.
- Replacement blade; can be replaced by pulling out the ball-grip part of No.2200.



| No.2200B | | Bit (mm) | | | | | | Inner Ctn. | Outer Ctn. | EDP No. |
|----------|-----|----------|-----|-----|-----|-----|----|------------|------------|---------|
| ⊖ 6× | 100 | 6.0 | 0.8 | 100 | 6.0 | 158 | 6 | 60 | 125397 | |
| ⊖ 6× | 150 | 6.0 | 0.8 | 150 | 6.0 | 208 | 6 | 60 | 125398 | |
| ⊕ 2× | 100 | ⊕No.2 | 100 | 6.0 | 158 | 6 | 60 | 125348 | | |
| ⊕ 2× | 150 | ⊕No.2 | 150 | 6.0 | 208 | 6 | 60 | 125349 | | |
| ⊕ 3× | 150 | ⊕No.3 | 150 | 6.0 | 208 | 6 | 60 | 125350 | | |

No. SC-90 Anti-drop Slim Cord NEW

- Cord to prevent screwdrivers from dropping.
- Provided with a sleeve to avoid rings forming, which cause the cord to get caught.



| Package content | | Inner Ctn. | EDP No. |
|-----------------|---|------------|---------|
| Mounted load | 500g or less | 10 | 125405 |
| Length | 482 (maximum length 1500) mm | | |
| Material | Sleeve: polypropylene | | |
| | Rubber band: polypropylene and natural rubber | | |

One point
Move the sleeve to straighten the cord!



HAND TOOLS

BITS & SOCKETS

ELECTRIC TOOLS

AIR TOOLS

STATIC SOLUTIONS

GASOLINE ENGINE TOOLS

No. 980

MEGADORA IMPACTA



Our proprietary Tang-thru nut incorporates cam rotation mechanism, which turns the driving tip counter-clockwise by 12 degrees when the handle is hit with a hammer.

IMPACTA leverages impact acceleration to remove stuck screws.

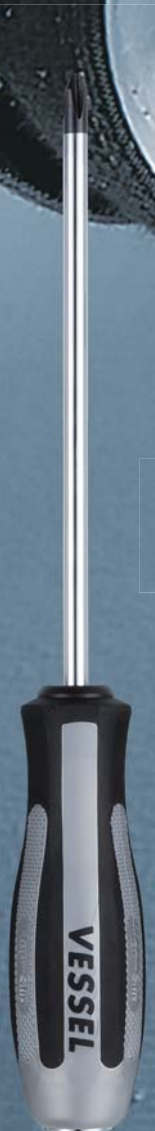

Distorted screws

Rusted screw

Stuck screws

12°

No. 980

MEGADORA IMPACTA

Equipped with a flat-surface grip and cushions on the corners of the hexagonal cross section. The inner core is a triple-layered construction using recycled resin, designed with practical use of resources.

※This is for illustrative purpose.

No. 980 MEGADORA IMPACTA PAT.

- Tang-Thru nut with cam rotation mechanism.
- High precision black point tip.



| No.980 | | | | | | | Inner Ctn. | Outer Ctn. | EDP No. |
|-----------|-------|-----|-----|----|-----|---|------------|------------|---------|
| ⊕ 2 × 100 | ⊕No.2 | 100 | 6.4 | 34 | 213 | 6 | 60 | 125941 | |
| ⊕ 2 × 150 | ⊕No.2 | 150 | 6.4 | 34 | 263 | 6 | 60 | 125942 | |
| ⊕ 3 × 150 | ⊕No.3 | 150 | 8.0 | 36 | 278 | 6 | 60 | 125943 | |

No. 900 MEGADORA Standard Screwdriver Extra Long Type PAT.

- Philips JAWSFIT tip that firmly grips the screw. **JAWSFIT**
- Good for a work deep in a space.
- Useful for adjustment of automotive headlight and removal of a hose band.
- Junk (turning) grip minimizes shaking because of the long shank, to ensure stable tightening.



| No.900 | | | | | | | Inner Ctn. | Outer Ctn. | EDP No. |
|-----------|-------|-----|-----|----|-----|---|------------|------------|---------|
| ⊖ 6 × 400 | ⊖No.2 | 400 | 6.4 | 34 | 510 | 6 | 60 | 125709 | |
| ⊕ 2 × 400 | ⊕No.2 | 400 | 6.4 | 34 | 510 | 6 | 60 | 125710 | |

No. 900 MEGADORA Standard Screwdriver PAT.

- NEW Philips JAWSFIT tip that firmly grips the screw. **JAWSFIT**
- A knurled shank is useful for fast and slipless turning by fingers and open wide holes on a wood material or a board.



| No.900 | | | | | | | Inner Ctn. | Outer Ctn. | EDP No. |
|------------|-------|-----|-----|-----|-----|-----|------------|------------|---------|
| ⊖ 5.5 × 75 | 5.5 | 0.8 | 75 | 5.5 | 30 | 175 | 6 | 60 | 125701 |
| ⊖ 6 × 100 | 6.0 | 0.9 | 100 | 6.4 | 34 | 210 | 6 | 60 | 125702 |
| ⊖ 6 × 150 | 6.0 | 0.9 | 150 | 6.4 | 34 | 260 | 6 | 60 | 125703 |
| ⊖ 8 × 150 | 8.0 | 1.1 | 150 | 8.0 | 36 | 275 | 6 | 60 | 125704 |
| ⊕ 1 × 75 | ⊕No.1 | 75 | 5.5 | 30 | 175 | 6 | 60 | 125705 | |
| ⊕ 2 × 100 | ⊕No.2 | 100 | 6.4 | 34 | 210 | 6 | 60 | 125706 | |
| ⊕ 2 × 150 | ⊕No.2 | 150 | 6.4 | 34 | 260 | 6 | 60 | 125707 | |
| ⊕ 3 × 150 | ⊕No.3 | 150 | 8.0 | 36 | 275 | 6 | 60 | 125708 | |

No. 920 MEGADORA Stubby Screwdriver

- Philips JAWSFIT tip that firmly grips the screw. **JAWSFIT**
- 25mm-long shank. Ideal for working in cramped places.

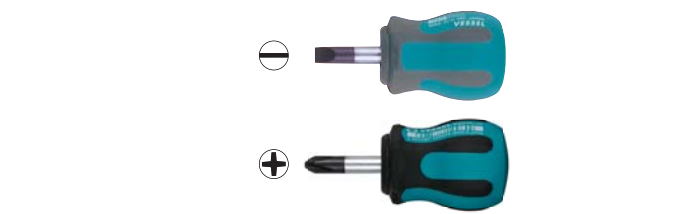

| No.920 | | | | | | | Inner Ctn. | Outer Ctn. | EDP No. |
|----------|-------|-----|-----|-----|----|----|------------|------------|---------|
| ⊖ 6 × 25 | 6.4 | 0.9 | 25 | 6.4 | 36 | 75 | 6 | 60 | 125752 |
| ⊕ 1 × 25 | ⊕No.1 | 25 | 6.4 | 36 | 75 | 6 | 60 | 125753 | |
| ⊕ 2 × 25 | ⊕No.2 | 25 | 6.4 | 36 | 75 | 6 | 60 | 125754 | |

No. 930 MEGADORA Tang-Thru Screwdriver PAT.

- NEW Philips JAWSFIT tip that firmly grips the screw. **JAWSFIT**
- Tang-Thru shank with large end cap.
- With a hexagonal bolster for spanner.



| No.930 | | | | | | | Inner Ctn. | Outer Ctn. | EDP No. | |
|------------|-------|-----|-----|-----|-----|-----|------------|------------|---------|--------|
| ⊖ 5.5 × 75 | 5.5 | 0.8 | 75 | 5.5 | 30 | 175 | 8 | 6 | 60 | 125711 |
| ⊖ 6 × 38 | 6.0 | 0.9 | 38 | 6.4 | 34 | 151 | — | 6 | 60 | 125719 |
| ⊖ 6 × 100 | 6.0 | 0.9 | 100 | 6.4 | 34 | 213 | 10 | 6 | 60 | 125712 |
| ⊖ 6 × 150 | 6.0 | 0.9 | 150 | 6.4 | 34 | 263 | 10 | 6 | 60 | 125713 |
| ⊖ 8 × 150 | 8.0 | 1.1 | 150 | 8.0 | 36 | 278 | 12 | 6 | 60 | 125714 |
| ⊕ 1 × 75 | ⊕No.1 | 75 | 5.5 | 30 | 176 | 8 | 6 | 60 | 125715 | |
| ⊕ 2 × 100 | ⊕No.2 | 100 | 6.4 | 34 | 213 | 10 | 6 | 60 | 125716 | |
| ⊕ 2 × 150 | ⊕No.2 | 150 | 6.4 | 34 | 263 | 10 | 6 | 60 | 125717 | |
| ⊕ 3 × 150 | ⊕No.3 | 150 | 8.0 | 36 | 278 | 12 | 6 | 60 | 125718 | |

No. 910 MEGADORA Thin Shank Screwdriver

- Precision type with 4 mm or smaller diameter shank.
- Black point tip, unaffected by the plating thickness.

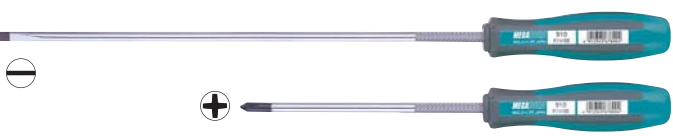

| No.910 | | | | | | | Inner Ctn. | Outer Ctn. | EDP No. |
|-----------|-------|-----|-----|-----|-----|-----|------------|------------|---------|
| ⊖ 3 × 75 | 3.0 | 0.4 | 75 | 3.0 | 21 | 153 | 12 | 120 | 125746 |
| ⊖ 3 × 100 | 3.0 | 0.4 | 100 | 3.0 | 21 | 178 | 12 | 120 | 125747 |
| ⊖ 4 × 75 | 4.0 | 0.5 | 75 | 4.0 | 21 | 153 | 12 | 120 | 125748 |
| ⊖ 4 × 100 | 4.0 | 0.5 | 100 | 4.0 | 21 | 178 | 12 | 120 | 125749 |
| ⊖ 4 × 150 | 4.0 | 0.5 | 150 | 4.0 | 21 | 228 | 12 | 120 | 125750 |
| ⊖ 4 × 200 | 4.0 | 0.5 | 200 | 4.0 | 21 | 278 | 12 | 120 | 125751 |
| ⊕ 0 × 75 | ⊕No.0 | 75 | 3.0 | 21 | 153 | 12 | 120 | 125742 | |
| ⊕ 0 × 100 | ⊕No.0 | 100 | 3.0 | 21 | 178 | 12 | 120 | 125743 | |
| ⊕ 1 × 75 | ⊕No.1 | 75 | 4.0 | 21 | 153 | 12 | 120 | 125744 | |
| ⊕ 1 × 100 | ⊕No.1 | 100 | 4.0 | 21 | 178 | 12 | 120 | 125745 | |

HAND TOOLS

BITS & SOCKETS

ELECTRIC TOOLS

AIR TOOLS

STATIC SOLUTIONS

GASOLINE ENGINE TOOLS

No. 970 MEGADORA Clip Remover **PAT.**

- One model for both large and small tips. Suited for many clips used with automobiles.
- Chrome plating, not causing scratches on a painted metal plate.
 - Optimally angled for working in cramped spaces, such as, door trim, wire binding clip, and so on.



| No.970 | CR × 120 | 12/7 | 120 | 7.0 | 34 | 230 | Inner Ctn. (mm) | Outer Ctn. | EDP No. |
|--------|----------|------|-----|-----|----|-----|-----------------|------------|---------|
| | | | | | | | 6 | 60 | 125721 |

No. 970 MEGADORA Chisel-Type Screwdriver **PAT.**

- Special steel for high quality cold chisel used. Hardness: 58HRC. Abrasion resistant and sharp edge.
- Elastomer-resin made grip absorbs shock when using and alleviate the fatigue on the hand.
 - Tang-Thru shank with large end cap. Less deformative case hardening nut.



| No.970 | 7 × 100 | 9.5 × 120 | 7.0 | 1.5 | 100 | 6 | 34 | 213 | Inner Ctn. (mm) | Outer Ctn. | EDP No. |
|--------|---------|-----------|-----|-----|-----|---|----|-----|-----------------|------------|---------|
| | | | 9.5 | 1.7 | 120 | 8 | 36 | 248 | 6 | 60 | 125722 |
| | | | | | | | | | 6 | 60 | 125732 |

One point

Pull out / Break



MEGADORA Clip Remover



One model compatible with 2 popular types of clip in the automobile industry.



High-grade chisel used.



Sharp edge and anti-abrasion quality. Good for removal of welding on a spot, of burrs, and for various work with tiles and bricks.



MEGADORA Chisel-Type Screwdriver

No. 944TX 4-Piece MEGADORA FOD TORX Screwdriver Set **PAT.**

- Used for work in automobile maintenance field
- Provided with a two-layer structured tray that prevents a screwdriver from being left.

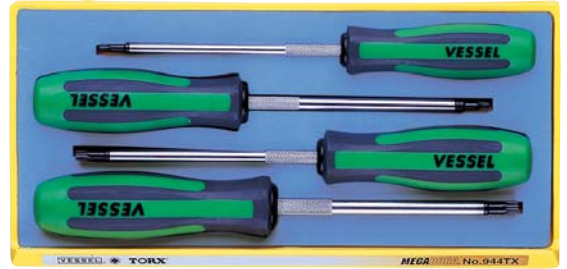

→See P45 One point

| No.940TX | Set content | Tray size (mm) | Inner Ctn. | Outer Ctn. | EDP No. |
|----------|--|----------------|------------|------------|---------|
| | T20H×120,T25H×120 T30H×120,T40H×120 | 280×135×35 | 1 | 20 | 125804 |

TORX® is a registered trademark of Acument™ Intellectual Properties, LLC (USA). VESSEL has a manufacturing license in Japan and selling same to the world.

No. S-903 MEGADORA Pozidriv Screwdriver

- Dedicated to Pozidriv screws.
- VESSEL is an official licensee of Pozidriv.
- A knurled shank is useful for fast turning.



| No.S-903 | PZ1 × 75 | PZ2 × 100 | PZ3 × 150 | 75 | 100 | 150 | 7.5 | 5.5 | 30 | 175 | Inner Ctn. (mm) | EDP No. |
|----------|----------|-----------|-----------|----|-----|-----|-----|-----|----|-----|-----------------|---------|
| | | | | | | | | | | | 6 | 267254 |
| | | | | | | | | | | | 6 | 267255 |
| | | | | | | | | | | | 6 | 267256 |

No. 6300

"CRYSTALINE" Screwdriver

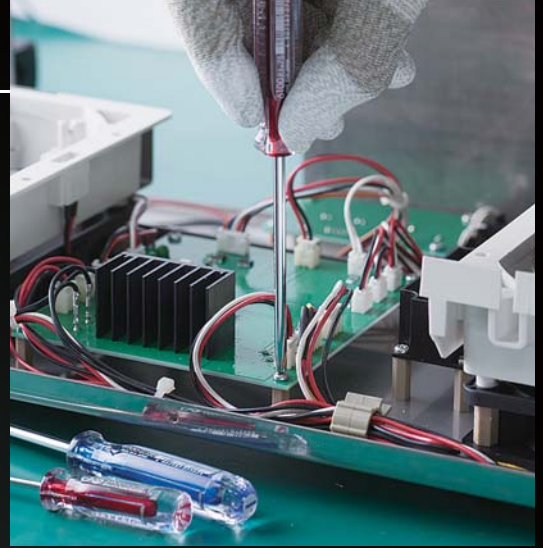

We have created a colorful grip with a crystalline sparkle. We offer an abundant lineup of shank sizes, including those capable of accessing deeply recessed or narrow areas.



No. 6300

"CRYSTALINE" Screwdriver

Uses cellulose acetate resin with good oil and chemical resistance. Uses raw materials such as wood and cotton (literal meaning of cellulose).

HAND TOOLS

BITS & SOCKETS

ELECTRIC TOOLS

AIR TOOLS

STATIC SOLUTIONS

GASOLINE ENGINE TOOLS

No. 6300 "CRYSTALINE" Screwdriver PAT.

- Bright quartz "CRYSTALINE" handles. Color coding by ⊕⊖.
- Uses cellulose acetate resin.



| No.6300 | | | | | | | Inner Ctn. | Outer Ctn. | EDP No. |
|------------|-------|-----|-----|------|------|-----|------------|------------|---------|
| ⊖ 4.5x 50 | 4.5 | 0.6 | 50 | 5.0 | 22.0 | 138 | 12 | 240 | 121201 |
| ⊖ 5.5x 75 | 5.5 | 0.8 | 75 | 5.5 | 22.0 | 163 | 12 | 240 | 121202 |
| ⊖ 6 x 100 | 6.0 | 0.9 | 100 | 6.0 | 26.5 | 205 | 12 | 240 | 121203 |
| ⊖ 8 x 150 | 8.0 | 1.1 | 150 | 8.0 | 28.5 | 263 | 12 | 120 | 121205 |
| ⊖ 9 x 200 | 9.0 | 1.2 | 200 | 9.0 | 28.5 | 313 | 6 | 60 | 121206 |
| ⊖ 10 x 250 | 10.0 | 1.2 | 250 | 9.0 | 28.5 | 363 | 6 | 60 | 121207 |
| ⊖ 10 x 300 | 10.0 | 1.2 | 300 | 9.0 | 28.5 | 413 | 6 | 60 | 121208 |
| ⊕ 1 x 75 | ⊕No.1 | 75 | 5.0 | 22.0 | 163 | | 12 | 240 | 121209 |
| ⊕ 2 x 100 | ⊕No.2 | 100 | 6.0 | 26.5 | 205 | | 12 | 240 | 121210 |
| ⊕ 3 x 150 | ⊕No.3 | 150 | 8.0 | 28.5 | 263 | | 12 | 120 | 121211 |
| ⊕ 4 x 200 | ⊕No.4 | 200 | 9.0 | 28.5 | 313 | | 6 | 60 | 121212 |

No. 6300 "CRYSTALINE" Screwdriver (Long Shank Type) PAT.

- Bright quartz "CRYSTALINE" handle. Marked for ⊕⊖.
- Long shank for fastening in a hard-to-reach space.
- Uses cellulose acetate resin.



| No.6300 | | | | | | | Inner Ctn. | Outer Ctn. | EDP No. |
|-----------|-------|-----|-----|------|-----|-----|------------|------------|---------|
| ⊖ 5 x 150 | 5.0 | 0.8 | 150 | 4.8 | 22 | 238 | 12 | 120 | 121213 |
| ⊖ 5 x 200 | 5.0 | 0.8 | 200 | 4.8 | 22 | 288 | 12 | 120 | 121214 |
| ⊖ 5 x 250 | 5.0 | 0.8 | 250 | 4.8 | 22 | 338 | 12 | 120 | 121215 |
| ⊕ 1 x 150 | ⊕No.1 | 150 | 4.8 | 22 | 238 | | 12 | 120 | 121216 |
| ⊕ 1 x 200 | ⊕No.1 | 200 | 4.8 | 22 | 288 | | 12 | 120 | 121217 |
| ⊕ 1 x 250 | ⊕No.1 | 250 | 4.8 | 22 | 338 | | 12 | 120 | 121218 |
| ⊕ 2 x 150 | ⊕No.2 | 150 | 6.0 | 26.5 | 255 | | 12 | 120 | 121219 |
| ⊕ 2 x 200 | ⊕No.2 | 200 | 6.0 | 26.5 | 305 | | 12 | 120 | 121220 |
| ⊕ 2 x 250 | ⊕No.2 | 250 | 6.0 | 26.5 | 355 | | 12 | 120 | 121221 |

No. 6900 "CRYSTALINE" Screwdriver (Precision Type) PAT.

- Bright quartz "CRYSTALINE" handle. Marked for ⊕⊖.
- For intense precision work.
- Handle butt is recessed to allow pressing with fingertips for fast turning.
- Uses cellulose acetate resin.

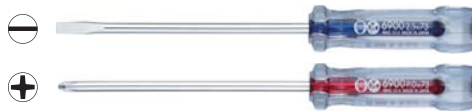

| No.6900 | | | | | | | Inner Ctn. | Outer Ctn. | EDP No. |
|------------|--------|------|-----|----|-----|-----|------------|------------|---------|
| ⊖ 2.5x 50 | 2.5 | 0.35 | 50 | 3 | 14 | 101 | 24 | 240 | 121301 |
| ⊖ 2.5x 75 | 2.5 | 0.35 | 75 | 3 | 14 | 126 | 24 | 240 | 121302 |
| ⊖ 2.5x 100 | 2.5 | 0.35 | 100 | 3 | 14 | 151 | 24 | 240 | 121303 |
| ⊕ 00x 50 | ⊕No.00 | 50 | 3 | 14 | 101 | | 24 | 240 | 121327 |
| ⊕ 0 x 75 | ⊕No.0 | 75 | 3 | 14 | 126 | | 24 | 240 | 121304 |

No. 6100 "CRYSTALINE" Screwdriver (Thin Shank Type) PAT.

- Bright quartz "CRYSTALINE" handle. Marked for ⊕⊖.
- Thin shank screwdriver. Ideal for working in cramped spaces.
- Uses cellulose acetate resin.



| No.6100 | | | | | | | Inner Ctn. | Outer Ctn. | EDP No. |
|-----------|-------|------|-----|----|-------|-------|------------|------------|---------|
| ⊖ 4 x 50 | 4.0 | 0.45 | 50 | 4 | 16 | 124.5 | 12 | 240 | 121001 |
| ⊖ 4 x 75 | 4.0 | 0.45 | 75 | 4 | 16 | 149.5 | 12 | 240 | 121002 |
| ⊖ 4 x 100 | 4.0 | 0.45 | 100 | 4 | 16 | 174.5 | 12 | 240 | 121003 |
| ⊖ 4 x 150 | 4.0 | 0.45 | 150 | 4 | 16 | 224.5 | 12 | 120 | 121005 |
| ⊖ 4 x 200 | 4.0 | 0.45 | 200 | 4 | 16 | 274.5 | 12 | 120 | 121006 |
| ⊕ 0 x 75 | ⊕No.0 | 75 | 4 | 16 | 149.5 | | 12 | 240 | 121323 |
| ⊕ 0 x 100 | ⊕No.0 | 100 | 4 | 16 | 174.5 | | 12 | 240 | 121009 |
| ⊕ 0 x 150 | ⊕No.0 | 150 | 4 | 16 | 224.5 | | 12 | 120 | 121325 |
| ⊕ 0 x 200 | ⊕No.0 | 200 | 4 | 16 | 274.5 | | 12 | 120 | 121326 |
| ⊕ 1 x 75 | ⊕No.1 | 75 | 4 | 16 | 149.5 | | 12 | 240 | 121008 |
| ⊕ 1 x 100 | ⊕No.1 | 100 | 4 | 16 | 174.5 | | 12 | 240 | 121012 |
| ⊕ 1 x 150 | ⊕No.1 | 150 | 4 | 16 | 224.5 | | 12 | 120 | 121013 |
| ⊕ 1 x 200 | ⊕No.1 | 200 | 4 | 16 | 274.5 | | 12 | 120 | 121014 |
| ⊕ 2 x 200 | ⊕No.2 | 200 | 4 | 16 | 274.5 | | 12 | 120 | 121015 |
| ⊕ 2 x 250 | ⊕No.2 | 250 | 4 | 16 | 324.5 | | 12 | 120 | 121016 |

No. 6200 "CRYSTALINE" Screwdriver (Stubby Type) PAT.

- Bright quartz "CRYSTALINE" handle. Marked for ⊕⊖.
- Ideal for working in cramped spaces.
- Uses cellulose acetate resin.



| No.6200 | | | | | | | Inner Ctn. | Outer Ctn. | EDP No. |
|----------|-------|-----|----|----|------|------|------------|------------|---------|
| ⊖ 6 x 38 | 6.0 | 0.9 | 38 | 6 | 30 | 87.5 | 12 | 240 | 121101 |
| ⊕ 1 x 38 | ⊕No.1 | 38 | 6 | 30 | 87.5 | | 12 | 240 | 121102 |
| ⊕ 2 x 38 | ⊕No.2 | 38 | 6 | 30 | 87.5 | | 12 | 240 | 121103 |

One point

An Eco-friendly grip made from plant-based ingredients

Cellulose acetate resin, used in many plastic screwdrivers, is once again in the spotlight as an ecologically friendly plant-based polyester resin. Cellulose acetate resin is an outstanding material that is resistant to oil, chemicals, and shock. As the word cellulose implies, the grip is made from wood pulp and cotton. This resin grip is ecologically friendly with a low environment load, and does not upset the CO2 balance when burned.



No. 6603 Long Square Shank Screwdriver PAT.

- 450mm-long square shank. Fully hardened tough special steel.
- Effective with high strength tightening.
- For fastening screws of sanitary appliances, etc.
- Uses cellulose acetate resin.



No.6603

| | | | | | | | Outer Ctn. (mm) | EDP No. |
|-----------|-------|-----|-----|-----|------|------|-----------------|----------|
| ⊖ 9 × 450 | 9.0 | 1.2 | 450 | 8 | 113 | 28.5 | 563 | 6 122231 |
| ⊕ 2 × 450 | ⊕No.2 | 450 | 6 | 113 | 28.5 | 563 | 6 | 122232 |
| ⊕ 3 × 450 | ⊕No.3 | 450 | 8 | 113 | 28.5 | 563 | 6 | 122233 |

No. 4500 Power Grip Screwdriver

- Plastic handle and tang-thru shank stand up to heavy-duty work.
- Hexagon bolster for strong tightening with a spanner or alike.
- Cellulose acetate resin grip. Ergonomic design.



No.4500

| | | | | | | | | Inner Ctn. (mm) | Outer Ctn. (mm) | EDP No. |
|------------|-------|-----|-----|------|------|-----|----|-----------------|-----------------|---------|
| ⊖ 5.5 × 75 | 5.5 | 0.8 | 75 | 5.8 | 28.0 | 172 | 8 | 6 | 240 | 123401 |
| ⊖ 6 × 100 | 6.0 | 0.9 | 100 | 6.4 | 31.8 | 204 | 10 | 6 | 120 | 123402 |
| ⊖ 8 × 150 | 8.0 | 1.1 | 150 | 8.0 | 35.6 | 265 | 12 | 6 | 120 | 123403 |
| ⊖ 9 × 200 | 9.0 | 1.2 | 200 | 9.0 | 37.0 | 320 | 12 | 6 | 60 | 123404 |
| ⊕ 1 × 75 | ⊕No.1 | 75 | 5.8 | 28.0 | 172 | 8 | 6 | 240 | 123405 | |
| ⊕ 2 × 100 | ⊕No.2 | 100 | 6.4 | 31.8 | 204 | 10 | 6 | 120 | 123406 | |
| ⊕ 3 × 150 | ⊕No.3 | 150 | 8.0 | 35.6 | 265 | 12 | 6 | 120 | 123407 | |
| ⊕ 4 × 200 | ⊕No.4 | 200 | 9.0 | 37.0 | 320 | 12 | 6 | 60 | 123408 | |

No. B-370 Non-slip tang-thru screwdrivers

- Unique Non-Slip finish that prevents slipping even if oil adheres on the grip.
- Tang-thru type with a large nut. Good for heavy duty work.
- The end of the handle has a color ring facilitates to distinguish the tip difference at a glance.



No.B-370

| | | | | | | | Inner Ctn. (mm) | Outer Ctn. (mm) | EDP No. |
|------------|-------|-----|-----|------|------|-----|-----------------|-----------------|---------|
| ⊖ 5.5 × 75 | 5.5 | 0.8 | 75 | 5.5 | 27.4 | 183 | 6 | 60 | 267590 |
| ⊖ 6 × 100 | 6.0 | 0.9 | 100 | 6.4 | 30.7 | 226 | 6 | 60 | 267591 |
| ⊖ 8 × 150 | 8.0 | 1.1 | 150 | 8.0 | 36.2 | 290 | 6 | 60 | 267592 |
| ⊕ 1 × 75 | ⊕No.1 | 75 | 5.5 | 27.4 | 183 | 6 | 60 | 267593 | |
| ⊕ 2 × 100 | ⊕No.2 | 100 | 6.4 | 30.7 | 226 | 6 | 60 | 267594 | |
| ⊕ 3 × 150 | ⊕No.3 | 150 | 8.0 | 36.2 | 290 | 6 | 60 | 267595 | |

No. 4100 Power Socket Screwdriver

- For fastening and loosening hexagon bolts and nuts.

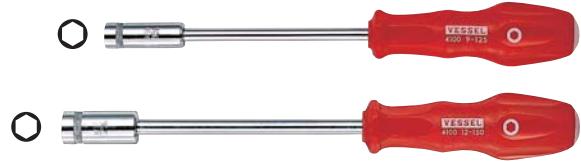

No.4100

| | | | | | | | | Inner Ctn. (mm) | Outer Ctn. (mm) | EDP No. |
|---------------|-----|------|----|-----|-----|------|-----|-----------------|-----------------|---------|
| A/F 5 × 115 | 5 | 8 | 18 | 115 | 5.0 | 28.0 | 212 | 6 | 60 | 123501 |
| A/F 5.5 × 115 | 5.5 | 9 | 18 | 115 | 5.0 | 28.0 | 212 | 6 | 60 | 123502 |
| A/F 6 × 115 | 6 | 9 | 18 | 115 | 5.5 | 28.0 | 212 | 6 | 60 | 123503 |
| A/F 7 × 125 | 7 | 10 | 18 | 125 | 5.5 | 28.0 | 222 | 6 | 60 | 123504 |
| A/F 8 × 125 | 8 | 12 | 20 | 125 | 5.5 | 31.8 | 229 | 6 | 60 | 123505 |
| A/F 9 × 125 | 9 | 12.7 | 20 | 125 | 6.3 | 31.8 | 229 | 6 | 60 | 123506 |
| A/F 10 × 125 | 10 | 15 | 20 | 125 | 7.0 | 35.6 | 240 | 6 | 60 | 123507 |
| A/F 11 × 125 | 11 | 15 | 20 | 125 | 7.0 | 35.6 | 240 | 6 | 60 | 123508 |
| A/F 12 × 150 | 12 | 17 | 20 | 150 | 8.0 | 35.6 | 265 | 6 | 60 | 123509 |
| A/F 13 × 150 | 13 | 19 | 20 | 150 | 8.0 | 35.6 | 265 | 6 | 60 | 123510 |

No. 4600 POZIDRIV Screwdriver

- High precision black point tip.
- Good for assembly of European and American furniture and skiing equipment.



No.4600

| | | | | | | Inner Ctn. (mm) | EDP No. |
|-----------|---------|-----|---|----|-----|-----------------|---------|
| PZ1 × 75 | PZ No.1 | 75 | 5 | 28 | 172 | 6 | 636011 |
| PZ2 × 100 | PZ No.2 | 100 | 6 | 31 | 204 | 6 | 636012 |
| PZ3 × 150 | PZ No.3 | 150 | 8 | 35 | 265 | 6 | 636013 |

No. 5400TX Power Grip TORX Screwdriver

- Champagne gold plating keeping the precise tip quality.
- Cellulose acetate resin grip. Ergonomic design.
- For working with tamper-proof screws (T5 and T6 excluded).



→ See P45 One point

No.5400TX

| | | | | | | | | Inner Ctn. (mm) | Outer Ctn. (mm) | EDP No. |
|------------|------|-----|-----|------|-----|----|----|-----------------|-----------------|---------|
| T 5 × 80 | 1.42 | 80 | 2.5 | 17.0 | 155 | 12 | 60 | 122854 | | |
| T 6 × 80 | 1.69 | 80 | 2.5 | 17.0 | 155 | 12 | 60 | 122855 | | |
| T 7H × 80 | 1.97 | 80 | 2.5 | 17.0 | 155 | 12 | 60 | 122856 | | |
| T 8H × 80 | 2.3 | 80 | 3.0 | 17.0 | 155 | 12 | 60 | 122857 | | |
| T 9H × 80 | 2.48 | 80 | 3.0 | 17.0 | 155 | 12 | 60 | 122858 | | |
| T10H × 80 | 2.72 | 80 | 3.0 | 17.0 | 155 | 12 | 60 | 122859 | | |
| T15H × 80 | 3.26 | 80 | 3.5 | 28.0 | 177 | 6 | 60 | 122860 | | |
| T20H × 120 | 3.84 | 120 | 4.0 | 28.0 | 217 | 6 | 60 | 122861 | | |
| T25H × 120 | 4.4 | 120 | 5.0 | 31.8 | 224 | 6 | 60 | 122862 | | |
| T27H × 120 | 4.96 | 120 | 5.0 | 31.8 | 224 | 6 | 60 | 122863 | | |
| T30H × 120 | 5.49 | 120 | 6.0 | 35.6 | 235 | 6 | 60 | 122864 | | |
| T40H × 120 | 6.6 | 120 | 7.0 | 35.6 | 235 | 6 | 60 | 122865 | | |

TORX® is a registered trademark of Acument TM Intellectual Properties, LLC (USA). VESSEL has a manufacturing license in Japan and selling same to the world.

HAND TOOLS

BITS & SOCKETS

ELECTRIC TOOLS

AIR TOOLS

STATIC SOLUTIONS

GASOLINE ENGINE TOOLS

No. B-5400BP Power Grip UltraBall Screwdriver

- Champagne gold plating keeping the precise tip quality.
- Cellulose acetate resin grip. Ergonomic design.
- A knurled shank keeps hands from slipping in fast turning.



| No. B-5400BP | Bit | Length (mm) | Shank Dia. (mm) | Tip Dia. (mm) | Tip Length (mm) | Overall Length (mm) | Outer Ctn. | EDP No. |
|--------------|-----|-------------|-----------------|---------------|-----------------|---------------------|------------|---------|
| H 1.5 × 80 | 1.5 | 80 | 2.5 | 17.0 | 155 | 30 | 267565 | |
| H 2 × 80 | 2 | 80 | 3.0 | 17.0 | 155 | 30 | 267566 | |
| H 2.5 × 80 | 2.5 | 80 | 3.0 | 17.0 | 155 | 30 | 267567 | |
| H 3 × 120 | 3 | 120 | 3.5 | 28.0 | 217 | 30 | 267568 | |
| H 4 × 120 | 4 | 120 | 5.0 | 31.8 | 224 | 30 | 267569 | |
| H 5 × 120 | 5 | 120 | 6.0 | 35.6 | 235 | 30 | 267570 | |
| H 6 × 120 | 6 | 120 | 7.0 | 35.6 | 235 | 30 | 267571 | |

No. TX-10 TORX Screwdriver Set

- Provided with bits in a holder.
- Also good for tamper-proof screws.
- New type of bit holder that assuredly holds bits.
- Bit insertion part ● 6.35mm
- Cellulose acetate resin grip. Ergonomic design.



| Set content | | Package size (mm) | Outer Ctn. | EDP No. |
|-------------|---|-------------------|------------|---------|
| Body | length 204mm dia. 31.8mm | 235×100×31 | 10 | 252020 |
| Bits | T10H, T15H, T20H, T25H, T27H, T30H, T40H, ⊕2, ⊕3, ⊕6×25.4mm | | | |
| Accessories | Bit belt holder | | | |

TORX® is a registered trademark of Acument TM Intellectual Properties, LLC (USA). VESSEL has a manufacturing license in Japan and selling same to the world.

No. TD-250Y/ 220B/ 240G 3-Point Screwdriver

- 3 sizes in 1 compact handy tool.
- Y-handle fits in the palm of the hand. Delivers powerful fastening strength.

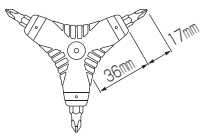

⊕ No. TD-250Y ● No. TD-220B ● No. TD-240G

| Model No. | Set content | Package size (mm) | Inner Ctn. | EDP No. |
|-----------|----------------|-------------------|------------|---------|
| TD-250Y | ⊕1 / ⊕2 / ⊕3 | 120×95×18 | 10 | 251211 |
| TD-220B | H2 / H2.5 / H3 | 120×95×18 | 10 | 251221 |
| TD-240G | H4 / H5 / H6 | 120×95×18 | 10 | 251222 |

No. TD-210 3-Point Cross Screwdriver

- 3 sizes in 1 compact handy tool.
- Y-handle fits in the palm of the hand. Delivers powerful fastening strength.

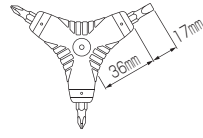

| Set content | Package size (mm) | Inner Ctn. | Outer Ctn. | EDP No. |
|--------------|-------------------|------------|------------|---------|
| ⊕1 / ⊕2 / ⊕6 | 135×120×20 | 10 | 60 | 251210 |

No. TD-6310HX Hex Screwdriver Set NEW

- Bit insertion part ● 6.35mm. Magnetized.
- Holds securely short bits. Reliable fastening as the bit does not drop easily.
- Grip made of environmental-friendly plant material.
- Provided with a bit belt for storage.



| Set content | | Package size (mm) | Outer Ctn. | EDP No. |
|-------------|---|-------------------|------------|---------|
| Body | length 213mm dia. 28.5mm | 235×100×29 | 10 | 247029 |
| Bits | ⊕4, ⊕6, ⊕4, ⊕4, ⊕4, H2.5, H3, H4, H5, H6×25.4mm | | | |
| Accessories | Bit belt holder | | | |

No. TD-6310TX TORX Screwdriver Set NEW

- Bit insertion part ● 6.35mm. Magnetized.
- Holds securely short bits. Reliable fastening as the bit does not drop easily.
- Grip made of environmental-friendly plant material.
- Provided with a bit belt for storage.



| Set content | | Package size (mm) | Outer Ctn. | EDP No. |
|-------------|--|-------------------|------------|---------|
| Body | length 213mm dia. 28.5mm | 235×100×29 | 10 | 247028 |
| Bits | ⊕6, ⊕2, T8H, T10H, T15H, T20H, T25H, T27H, T30H, T40H×25.4mm | | | |
| Accessories | Bit belt holder | | | |

TORX® is a registered trademark of Acument TM Intellectual Properties, LLC (USA). VESSEL has a manufacturing license in Japan and selling same to the world.

No. TD-800 "FAMIDORA 8" Screwdriver 8-Piece Set

- Ergonomic handle that fits in the palm of the hand.
- Color-coded interchangeable driver blades.
- Provided with a screwdriver stand, which is convenient for storage.



| Set content | | Package size (mm) | Inner Ctn. | Outer Ctn. | EDP No. |
|---------------|--|-------------------|------------|------------|---------|
| Handle | length 100mm dia. 29.5mm | | | | |
| Driver blades | Φ0, Φ1, Φ2, Φ2.5, Φ4, Φ6, Awl, Pin extractor×128mm | | | | |

No. TD-410 "FAMIDORA" Reversible Blade Screwdriver

- Ergonomic handle that fits in the palm of the hand.
- Fully hardened shank. Tough tip.



| Set content | | Package size (mm) | Inner Ctn. | Outer Ctn. | EDP No. |
|---------------|--------------------------|-------------------|------------|------------|---------|
| Handle | length 101.5mm dia. 29mm | | | | |
| Driver blades | Φ2 / Φ6×150mm | | | | |

No. TD-808 "FAMIDORA W8" Screwdriver Set

- Ergonomic handle that fits in the palm of the hand.
- Reversible blades. Each blade has 2-sized ends.
- Fully hardened alloy steel shank. ● Provided with a transparent case.



| Set content | | Package size (mm) | Inner Ctn. | Outer Ctn. | EDP No. |
|---------------|---|-------------------|------------|------------|---------|
| Handle | length 100mm dia. 29.5mm | | | | |
| Driver blades | Φ0/Φ2.5, Φ1/Φ4, Φ2/Φ6, Awl, Pin extractor×120mm | | | | |

No. TD-2100 "Dual-Tone" Screwdriver Set NEW

- Set of a handle and interchangeable blades, convenient for repair/disassembly of electric goods, toys, and equipment instruments.
- Octagonal grip effectively transmitting fastening force; made of polypropylene, oil and chemical resistant.
- Blades have a thin non-electrolytic plating layer and fits screws.
- Magnetized tip catching screws. ● Provided with a handy bag.



| Set content | | Package size (mm) | Inner Ctn. | EDP No. |
|---------------|------------------------|-------------------|------------|---------|
| Handle | length 100mm dia. 30mm | | | |
| Driver blades | Φ1, Φ2, Φ4, Φ6×120mm | | | |

One point

Features of the FAMIDORA series
Small handle / Big handle

Compact design useful as a standing set in households, offices, stores, etc.



Small handle

Big handle

Without big handle, the screwdriver can be used.



In a drawer

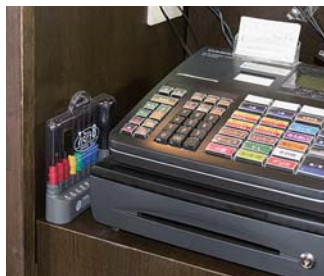

In a gap beside a cash register



For mounting hardware



For fastening a sign with screws

HAND TOOLS

BITS & SOCKETS

ELECTRIC TOOLS

AIR TOOLS

STATIC SOLUTIONS

GASOLINE ENGINE TOOLS

No. 550

"SEPADORA" Screwdriver



Environmentally friendly products with low environmental impacts are desired in corporate activities.

All are ecological when held by hand.



Elastomer wrapping the grip holds the shank.



No. 550
"SEPADORA"
Screwdriver

Eco screwdrivers of the special manufacturing process that enables the shank and the handle to be separated.

The ergonomic grip designed in the motif of a leaf is superior in tightening force.

⚠ Caution (SEPADORA)

- Eco screwdrivers are not tang-thru screwdrivers; hitting a screwdriver with a hammer disables the shank from being pulled out or causes it to be deformed or broken.

※ This is for illustrative purpose.

No. 550 "SEPADORA" Screwdriver PAT.

- Shank and grip are separable. Sort and recycle.
- Wavy octagonal grip fits your palm and transmits driving torque effectively.



← See P21

| No.550 | Tip | Length (mm) | Inner Ctn. | Outer Ctn. | EDP No. |
|------------|-------------|--------------|------------|------------|---------|
| ⊖ 5.5 × 75 | 5.5 0.8 75 | 5.0 30.0 175 | 6 | 120 | 121601 |
| ⊖ 6 × 100 | 6.0 0.9 100 | 6.0 33.5 210 | 6 | 60 | 121602 |
| ⊖ 8 × 150 | 8.0 1.1 150 | 8.0 36.0 275 | 6 | 60 | 121603 |
| ⊕ 1 × 75 | ⊕No.1 75 | 5.0 30.0 175 | 6 | 120 | 121611 |
| ⊕ 2 × 100 | ⊕No.2 100 | 6.0 33.5 210 | 6 | 60 | 121612 |
| ⊕ 2 × 150 | ⊕No.2 150 | 6.0 33.5 260 | 6 | 60 | 121613 |
| ⊕ 3 × 150 | ⊕No.3 150 | 8.0 36.0 275 | 6 | 60 | 121616 |

No. 590 "SEPADORA" Screwdriver (Precision Type) PAT.

- Shank and grip are separable. Sort and recycle.
- Wavy octagonal grip fits your palm and transmits driving torque effectively.
- Special grip with a clip.
- Thin shank screwdriver. Ideal for screw tightening in precision fields.
- ※ ⊕00×50 is with a fully black oxide finish shank.



| No.590 | Tip | Length (mm) | Inner Ctn. | Outer Ctn. | EDP No. |
|-------------|--------------|--------------|------------|------------|---------|
| ⊖ 2.5 × 50 | 2.5 0.35 50 | 3.0 15.4 99 | 24 | 480 | 121671 |
| ⊖ 2.5 × 75 | 2.5 0.35 75 | 3.0 15.4 124 | 24 | 480 | 121672 |
| ⊖ 2.5 × 100 | 2.5 0.35 100 | 3.0 15.4 149 | 24 | 480 | 121673 |
| ⊕ 00 × 50 | ⊕No.00 50 | 3.0 15.4 99 | 24 | 480 | 121674 |
| ⊕ 0 × 75 | ⊕No.0 75 | 3.0 15.4 124 | 24 | 480 | 121675 |

No. 560 "SEPADORA" Screwdriver (Thin Shank Type) PAT.

- Shank and grip are separable. Sort and recycle.
- Wavy octagonal grip fits your palm and transmits driving torque effectively.
- Thin shank screwdriver. Ideal for screw tightening in narrow spaces.



| No.560 | Tip | Length (mm) | Inner Ctn. | Outer Ctn. | EDP No. |
|-----------|-------------|--------------|------------|------------|---------|
| ⊖ 4 × 75 | 4.0 0.5 75 | 4.0 19.8 153 | 12 | 240 | 121632 |
| ⊖ 4 × 100 | 4.0 0.5 100 | 4.0 19.8 178 | 12 | 240 | 121633 |
| ⊖ 4 × 150 | 4.0 0.5 150 | 4.0 19.8 228 | 12 | 240 | 121634 |
| ⊖ 4 × 200 | 4.0 0.5 200 | 4.0 19.8 278 | 12 | 240 | 121635 |
| ⊕ 0 × 75 | ⊕No.0 75 | 4.0 19.8 153 | 12 | 240 | 121642 |
| ⊕ 1 × 100 | ⊕No.1 100 | 4.0 19.8 178 | 12 | 240 | 121647 |
| ⊕ 2 × 150 | ⊕No.2 150 | 4.0 19.8 228 | 12 | 240 | 121651 |

No. 570 "SEPADORA" Screwdriver (Stubby Type) PAT.

- Shank and grip are separable. Sort and recycle.
- Wavy octagonal grip fits your palm and transmits driving torque effectively.
- Ideal for working in cramped places.



| No.570 | Tip | Length (mm) | Inner Ctn. | Outer Ctn. | EDP No. |
|----------|------------|-------------|------------|------------|---------|
| ⊖ 6 × 25 | 6.0 0.9 25 | 6.0 45 50 | 12 | 240 | 121661 |
| ⊕ 1 × 25 | ⊕No.1 25 | 6.0 45 50 | 12 | 240 | 121662 |
| ⊕ 2 × 25 | ⊕No.2 25 | 6.0 45 50 | 12 | 240 | 121663 |

One point

Concave octagonal grip

Dents and projections of the waves fit into your palm to transmit the torque securely.

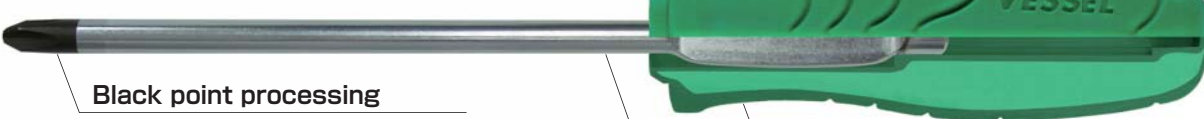

Tip shape is shown on the grip end

Black point processing

High precision finish, unaffected by plate thickness

Rust-proof chrome plating

Elastomer grip

The elastomer resin coating on the surface is slip-proof and fits into your palm

HAND TOOLS

BITS & SOCKETS

ELECTRIC TOOLS

AIR TOOLS

STATIC SOLUTIONS

GASOLINE ENGINE TOOLS

No.500 ECO VALUE Screwdriver

- Robust looking black hard grip.
- Wavy octagonal grip fits your palm and transmits driving torque effectively.
- Champagne gold plating, keeping the precise tip quality.



| No.500 | | | | | | | Inner Ctn. | Outer Ctn. | EDP No. |
|------------|-------|-----|-----|------|------|-----|------------|------------|---------|
| ⊖ 5.5 × 75 | 5.5 | 0.8 | 75 | 5.0 | 30.0 | 175 | 6 | 120 | 121751 |
| ⊖ 6 × 100 | 6.0 | 0.9 | 100 | 6.0 | 33.5 | 210 | 6 | 60 | 121752 |
| ⊖ 8 × 150 | 8.0 | 1.1 | 150 | 8.0 | 36.0 | 275 | 6 | 60 | 121753 |
| ⊕ 1 × 75 | ⊕No.1 | 75 | 5.0 | 30.0 | 175 | | 6 | 120 | 121761 |
| ⊕ 2 × 100 | ⊕No.2 | 100 | 6.0 | 33.5 | 210 | | 6 | 60 | 121762 |
| ⊕ 3 × 150 | ⊕No.3 | 150 | 8.0 | 36.0 | 275 | | 6 | 60 | 121766 |

※The shank is not separable.

No.510 ECO VALUE Screwdriver

- Robust looking black hard grip.
- Wavy octagonal grip fits your palm and transmits driving torque effectively.
- Thin shank screwdriver. Ideal for screw tightening in narrow spaces.
- Champagne gold plating, keeping the precise tip quality.



| No.510 | | | | | | | Inner Ctn. | Outer Ctn. | EDP No. |
|-----------|-------|------|-----|------|------|-----|------------|------------|---------|
| ⊖ 4 × 75 | 4.0 | 0.45 | 75 | 4.0 | 19.8 | 153 | 12 | 240 | 121782 |
| ⊖ 4 × 100 | 4.0 | 0.45 | 100 | 4.0 | 19.8 | 178 | 12 | 240 | 121783 |
| ⊕ 0 × 75 | ⊕No.0 | 75 | 4.0 | 19.8 | 153 | | 12 | 240 | 121792 |
| ⊕ 1 × 100 | ⊕No.1 | 100 | 4.0 | 19.8 | 178 | | 12 | 240 | 121797 |

※The shank is not separable.

No.540 ECO VALUE Screwdriver (Precision Type)

- Robust looking black hard grip.
- Wavy octagonal grip fits your palm and transmits driving torque effectively.
- Special grip with a clip.
- Thin shank screwdriver. Ideal for screw tightening in precision fields.
- Champagne gold plating, keeping the precise tip quality.



| No.540 | | | | | | | Inner Ctn. | Outer Ctn. | EDP No. |
|------------|--------|------|-----|------|------|----|------------|------------|---------|
| ⊖ 2.5 × 50 | 2.5 | 0.35 | 50 | 3.0 | 15.4 | 99 | 24 | 480 | 121821 |
| ⊕ 00 × 50 | ⊕No.00 | 50 | 3.0 | 15.4 | 99 | | 24 | 480 | 121824 |
| ⊕ 0 × 75 | ⊕No.0 | 75 | 3.0 | 15.4 | 124 | | 24 | 480 | 121825 |

※The shank is not separable.

No.520 ECO VALUE Screwdriver (Stubby Type)

- Robust looking black hard grip.
- Wavy octagonal grip fits your palm and transmits driving torque effectively.
- Ideal for working in cramped spaces.
- Champagne gold plating, keeping the precise tip quality.



| No.520 | | | | | | | Inner Ctn. | Outer Ctn. | EDP No. |
|----------|-------|-----|-----|-----|----|----|------------|------------|---------|
| ⊖ 6 × 25 | 6.0 | 0.9 | 25 | 6.0 | 45 | 50 | 12 | 240 | 121811 |
| ⊕ 1 × 25 | ⊕No.1 | 25 | 6.0 | 45 | 50 | | 12 | 240 | 121812 |
| ⊕ 2 × 25 | ⊕No.2 | 25 | 6.0 | 45 | 50 | | 12 | 240 | 121813 |

※The shank is not separable.

No.460NT-9S ECOSOFT T-bar screwdriver (w/socket bit set)

- The ergonomic grip fits comfortably in your hand. T-shaped handle transmits high torque without applying too much force by your hand.
- Ball-lock type holds a socket assuredly. Hex drive 6.35mm.



| Set content | | Package size (mm) | Inner Ctn. | Outer Ctn. | EDP No. |
|-------------|--|-------------------|------------|------------|---------|
| Body | length 165.5mm dia. 100mm | | | | |
| Socket bits | A/F5, A/F5.5, A/F6, A/F7, A/F8, A/F9, A/F10, A/F12, A/F13 × 26.5mm | 235×120×30 | 5 | 30 | 121891 |
| Accessories | Socket bit holder | | | | |

※The shank is not separable.

No. 100

Powerful Tang-Thru Screwdriver



Luxurious furniture finish coating on the large handle, which fits more comfortably in your hand the more you use it.

Its better usability compared to plastic handles attracts support from many professional users.



No. 100

Powerful Tang-Thru Screwdriver

Especially large, heavy-duty end cap. An especially large end cap efficiently delivers the shock of the hammer blow.

When tapped with a hammer, and adjusting the force of the tapping to the condition of the material concerned, this screwdriver can be used effectively to loosen stripped or rusted screws.

※This is for illustrative purpose.

HAND TOOLS

BITS & SOCKETS

ELECTRIC TOOLS

AIR TOOLS

STATIC SOLUTIONS

GASOLINE ENGINE TOOLS

No. 100 Powerful Tang-Thru Screwdriver

- Wooden handle and Tang-Thru shank with thick end cap.
- Large and long grip comfortable to hold.
- Black point tip.



← See P24

| No.100 | Tip Dimensions (mm) | | | | | | Inner Ctn. | Outer Ctn. | EDP No. |
|------------|---------------------|---------|-----------|-----------|---------|---------|------------|------------|---------|
| | Tip Dia | Tip Len | Shank Dia | Shank Len | Tip Dia | Tip Len | | | |
| ⊖ 5.5 × 75 | 5.5 | 0.8 | 75 | 5.8 | 27.0 | 182 | 6 | 120 | 111051 |
| ⊖ 6 × 100 | 6.0 | 0.9 | 100 | 6.4 | 30.5 | 223 | 6 | 120 | 111052 |
| ⊖ 6 × 300 | 6.0 | 0.9 | 300 | 6.4 | 30.5 | 423 | 6 | 60 | 111061 |
| ⊖ 8 × 150 | 8.0 | 1.1 | 150 | 8.0 | 34.0 | 294 | 6 | 120 | 111053 |
| ⊕ 1 × 75 | ⊕No.1 | 75 | 5.8 | 27.0 | 182 | | 6 | 120 | 111054 |
| ⊕ 2 × 100 | ⊕No.2 | 100 | 6.4 | 30.5 | 223 | | 6 | 120 | 111055 |
| ⊕ 2 × 300 | ⊕No.2 | 300 | 6.4 | 30.5 | 423 | | 6 | 60 | 111066 |
| ⊕ 3 × 150 | ⊕No.3 | 150 | 8.0 | 34.0 | 294 | | 6 | 120 | 111056 |

No. 110 Wooden Handle Socket Driver

- For fastening and loosening hexagon bolts and nuts.
- Tip is made of specially treated steel to enhance wear resistance.

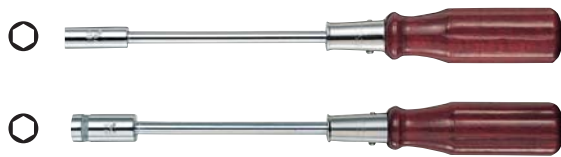

| No.110 | Tip Dimensions (mm) | | | | | | Inner Ctn. | Outer Ctn. | EDP No. | |
|--------------|---------------------|---------|-----------|-----------|---------|---------|------------|------------|---------|--------|
| | Tip Dia | Tip Len | Shank Dia | Shank Len | Tip Dia | Tip Len | | | | |
| A/F 5 × 115 | 5 | 8 | 18 | 115 | 5 | 23 | 210 | 12 | 120 | 113002 |
| A/F 6 × 115 | 6 | 9 | 18 | 115 | 5.5 | 25 | 220 | 12 | 240 | 113004 |
| A/F 9 × 125 | 9 | 12.7 | 20 | 125 | 6.3 | 28 | 250 | 12 | 120 | 113007 |
| A/F 11 × 125 | 11 | 15 | 20 | 125 | 6.3 | 28 | 250 | 12 | 120 | 113009 |
| A/F 12 × 150 | 12 | 17 | 20 | 150 | 8 | 33 | 292 | 6 | — | 113010 |
| A/F 14 × 150 | 14 | 19 | 22 | 150 | 8 | 33 | 292 | 6 | — | 113012 |
| A/F 17 × 150 | 17 | 23 | 22 | 150 | 9 | 35 | 313 | 6 | — | 113013 |

No. 310 Wooden Handle standard Shank Screwdriver

- Widely-used standard wooden handle screwdriver.
- Mahogany colored handle. Easy-to-grip texture and shape.
- Shot blasting tip.



| No.310 | Tip Dimensions (mm) | | | | | | Inner Ctn. | Outer Ctn. | EDP No. |
|------------|---------------------|---------|-----------|-----------|---------|---------|------------|------------|---------|
| | Tip Dia | Tip Len | Shank Dia | Shank Len | Tip Dia | Tip Len | | | |
| ⊖ 5.5 × 75 | 5.5 | 0.8 | 75 | 5.5 | 25 | 181 | 12 | 120 | 111102 |
| ⊖ 8 × 150 | 8 | 1.1 | 150 | 8 | 33 | 292 | 6 | 120 | 111105 |
| ⊕ 2 × 100 | ⊕No.2 | 100 | 6.3 | 28 | 225 | | 12 | 240 | 111111 |

No. 350 Wooden Handle Tang-Thru Screwdriver

- Widely-used standard wooden handle screwdriver.
- Wooden handle and Tang-Thru shank with large end cap.
- Shot blasting tip.



| No.350 | Tip Dimensions (mm) | | | | | | Inner Ctn. | Outer Ctn. | EDP No. |
|------------|---------------------|---------|-----------|-----------|---------|---------|------------|------------|---------|
| | Tip Dia | Tip Len | Shank Dia | Shank Len | Tip Dia | Tip Len | | | |
| ⊖ 4.5 × 50 | 4.5 | 0.6 | 50 | 5.0 | 25 | 153 | 12 | 120 | 111001 |
| ⊖ 5.5 × 75 | 5.5 | 0.8 | 75 | 5.5 | 25 | 178 | 12 | 120 | 111002 |
| ⊖ 6 × 100 | 6.0 | 0.9 | 100 | 6.3 | 28 | 218 | 12 | 240 | 111003 |
| ⊖ 7 × 125 | 7.0 | 0.9 | 125 | 7.0 | 33 | 258 | 6 | 120 | 111004 |
| ⊖ 8 × 150 | 8.0 | 1.1 | 150 | 8.0 | 33 | 283 | 6 | 120 | 111005 |
| ⊖ 9 × 200 | 9.0 | 1.2 | 200 | 9.0 | 36 | 355 | 6 | 60 | 111006 |
| ⊖ 10 × 300 | 10.0 | 1.2 | 300 | 9.0 | 36 | 455 | 6 | 60 | 111008 |
| ⊕ 0 × 75 | ⊕No.0 | 75 | 5.0 | 25 | 178 | | 12 | 120 | 111009 |
| ⊕ 1 × 75 | ⊕No.1 | 75 | 5.0 | 25 | 178 | | 12 | 120 | 111010 |
| ⊕ 2 × 100 | ⊕No.2 | 100 | 6.3 | 28 | 218 | | 12 | 240 | 111011 |
| ⊕ 3 × 150 | ⊕No.3 | 150 | 8.0 | 33 | 283 | | 6 | 120 | 111012 |
| ⊕ 4 × 200 | ⊕No.4 | 200 | 9.0 | 36 | 355 | | 6 | 60 | 111013 |

No. 350 Wooden Handle Tang-Thru Screwdriver (Long Shank Type)

- Wooden handle and Tang-Thru shank.
- Long shank for fastening in a hard-to-reach space.

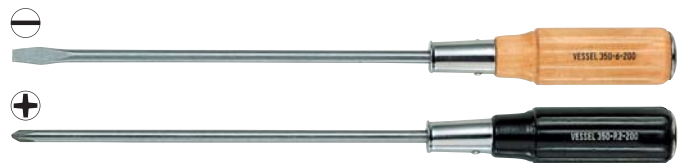

| No.350 | Tip Dimensions (mm) | | | | | | Inner Ctn. | Outer Ctn. | EDP No. |
|-----------|---------------------|---------|-----------|-----------|---------|---------|------------|------------|---------|
| | Tip Dia | Tip Len | Shank Dia | Shank Len | Tip Dia | Tip Len | | | |
| ⊖ 6 × 200 | 6.0 | 0.9 | 200 | 6.3 | 28 | 320 | 12 | 120 | 111018 |
| ⊖ 6 × 250 | 6.0 | 0.9 | 250 | 6.3 | 28 | 370 | 12 | 120 | 111019 |
| ⊖ 6 × 300 | 6.0 | 0.9 | 300 | 6.3 | 28 | 420 | 12 | 120 | 111020 |
| ⊕ 2 × 200 | ⊕No.2 | 200 | 6.3 | 28 | 320 | | 12 | 120 | 111024 |
| ⊕ 2 × 250 | ⊕No.2 | 250 | 6.3 | 28 | 370 | | 12 | 120 | 111025 |
| ⊕ 2 × 300 | ⊕No.2 | 300 | 6.3 | 28 | 420 | | 12 | 120 | 111026 |

No. 30 "SPLIT" Handle Screwdriver

- Joined Tang-Thru shank and handle. Super strong type.

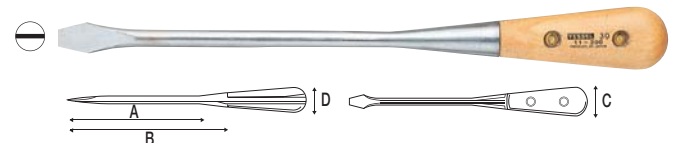

| No.30 | Tip Dimensions (mm) | | | | | | Inner Ctn. | Outer Ctn. | EDP No. | | |
|-------------|---------------------|---------|-----------|-----------|---------|---------|------------|------------|---------|-----|--------|
| | Tip Dia | Tip Len | Shank Dia | Shank Len | Tip Dia | Tip Len | | | | | |
| ⊖ 9.5 × 150 | 9.5 | 1.2 | 9.5 | 145 | 190 | 35 | 29 | 285 | 6 | 120 | 113101 |
| ⊖ 11 × 200 | 11 | 1.2 | 11 | 195 | 255 | 38 | 32 | 360 | 6 | 120 | 113102 |

HAND TOOLS

BITS & SOCKETS

ELECTRIC TOOLS

AIR TOOLS

STATIC SOLUTIONS

GASOLINE ENGINE TOOLS

No. 300

Wood-Compo Screwdriver



Maintenance of cars, motorbikes and machines always involves oils. Wood-compo screwdriver's coarse wood powder on the grip surface stops the oil flow against the tightening torque, producing an outstanding non-slip grip effect.

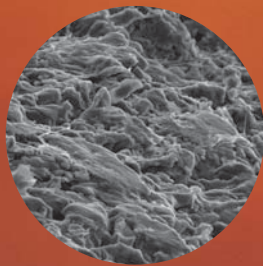

A D V A N C E D

NON-SLIP

T E C H N O L O G Y

No. 300

Wood-Compo Screwdriver

The grip part is made by unique mold injection technique for "wood resin" which is a compound of wood powder and plastic. Wood powder is the main material, realizing texture and feeling to fit comfortably in your hand like those made of natural wood.

※ This is for illustrative purpose.

HAND TOOLS

BITS & SOCKETS



ELECTRIC TOOLS

AIR TOOLS

STATIC SOLUTIONS

GASOLINE ENGINE TOOLS



No. 300 Wood-Compo Screwdriver NEW PAT.

- Extraordinary non-slip grip; Secure working efficiency even with oily hands.   
- Wood-composite resin, reproducing the natural material texture.
- Rust-resistant black chrome plating shank.



| No.300 | |  | | | | | Inner Ctn. | Outer Ctn. | EDP No. | |
|--------|-----|---|-----|-----|-----|-----|------------|------------|---------|--------|
| ⊖ 5.5x | 75 | 5.5 | 0.8 | 75 | 5.5 | 30 | 182 | 6 | 120 | 120021 |
| ⊖ 6x | 100 | 6.0 | 0.9 | 100 | 6.4 | 32 | 215 | 6 | 120 | 120022 |
| ⊖ 6x | 150 | 6.0 | 0.9 | 150 | 6.4 | 32 | 265 | 6 | 120 | 120027 |
| ⊖ 8x | 150 | 8.0 | 1.1 | 150 | 8.0 | 35 | 275 | 6 | 120 | 120023 |
| ⊕ 1x | 75 | ⊕No.1 | 75 | 5.5 | 30 | 182 | 6 | 120 | 120024 | |
| ⊕ 2x | 100 | ⊕No.2 | 100 | 6.4 | 32 | 215 | 6 | 120 | 120025 | |
| ⊕ 2x | 150 | ⊕No.2 | 150 | 6.4 | 32 | 265 | 6 | 120 | 120029 | |
| ⊕ 3x | 150 | ⊕No.3 | 150 | 8.0 | 35 | 275 | 6 | 120 | 120026 | |



No. B-330 Wood-Compo Tang-Thru Screwdriver NEW PAT.

- Extraordinary non-slip grip; Secure working efficiency even with oily hands.   
- Tang-thru type, which can be tapped by a hammer. With star-shaped nut.
- Rust-resistant black chrome plating shank.



| No.B-330 | |  | | | | | Inner Ctn. | Outer Ctn. | EDP No. | |
|----------|-----|--|-----|-----|-----|-----|------------|------------|---------|--------|
| ⊖ 5.5x | 75 | 5.5 | 0.8 | 75 | 5.5 | 30 | 183 | 6 | 120 | 120041 |
| ⊖ 6x | 100 | 6.0 | 0.9 | 100 | 6.4 | 32 | 217 | 6 | 120 | 120042 |
| ⊖ 6x | 150 | 6.0 | 0.9 | 150 | 6.4 | 32 | 267 | 6 | 60 | 120043 |
| ⊖ 8x | 150 | 8.0 | 1.1 | 150 | 8.0 | 35 | 277 | 6 | 60 | 120044 |
| ⊕ 1x | 75 | ⊕No.1 | 75 | 5.5 | 30 | 183 | 6 | 120 | 120045 | |
| ⊕ 2x | 100 | ⊕No.2 | 100 | 6.4 | 32 | 217 | 6 | 120 | 120046 | |
| ⊕ 2x | 150 | ⊕No.2 | 150 | 6.4 | 32 | 267 | 6 | 60 | 120047 | |
| ⊕ 3x | 150 | ⊕No.3 | 150 | 8.0 | 35 | 277 | 6 | 60 | 120048 | |



No. B-300 Wood-Compo S/D (w/hanging card) NEW PAT.

- Extraordinary non-slip grip; Secure working efficiency even with oily hands.   
- Wood-composite resin, reproducing the natural material texture.
- Rust-resistant black chrome plating shank.



| No.B-300 | |  | | | | | Inner Ctn. | Outer Ctn. | EDP No. | |
|----------|-----|---|-----|-----|-----|-----|------------|------------|---------|--------|
| ⊖ 5.5x | 75 | 5.5 | 0.8 | 75 | 5.5 | 30 | 183 | 6 | 120 | 120071 |
| ⊖ 6x | 100 | 6.0 | 0.9 | 100 | 6.4 | 32 | 217 | 6 | 120 | 120072 |
| ⊖ 6x | 150 | 6.0 | 0.9 | 150 | 6.4 | 32 | 267 | 6 | 60 | 120073 |
| ⊖ 8x | 150 | 8.0 | 1.1 | 150 | 8.0 | 35 | 277 | 6 | 60 | 120074 |
| ⊕ 1x | 75 | ⊕No.1 | 75 | 5.5 | 30 | 183 | 6 | 120 | 120075 | |
| ⊕ 2x | 100 | ⊕No.2 | 100 | 6.4 | 32 | 217 | 6 | 120 | 120076 | |
| ⊕ 2x | 150 | ⊕No.2 | 150 | 6.4 | 32 | 267 | 6 | 60 | 120077 | |
| ⊕ 3x | 150 | ⊕No.3 | 150 | 8.0 | 35 | 277 | 6 | 60 | 120078 | |

No. 320 Wood-Compo Screwdriver (Stubby Type) NEW PAT.

- Stubby type, which is convenient for tightening screws in cramped spaces.   
- Wood-composite resin, reproducing the natural material texture.
- Rust-resistant black chrome plating shank.



| No.320 | |  | | | | | Inner Ctn. | Outer Ctn. | EDP No. | |
|--------|----|---|-----|-----|-----|----|------------|------------|---------|--------|
| ⊖ 6x | 15 | 6.0 | 0.9 | 15 | 6.0 | 35 | 68 | 6 | 120 | 120035 |
| ⊕ 2x | 15 | ⊕No.2 | 15 | 6.0 | 35 | 68 | 6 | 120 | 120037 | |

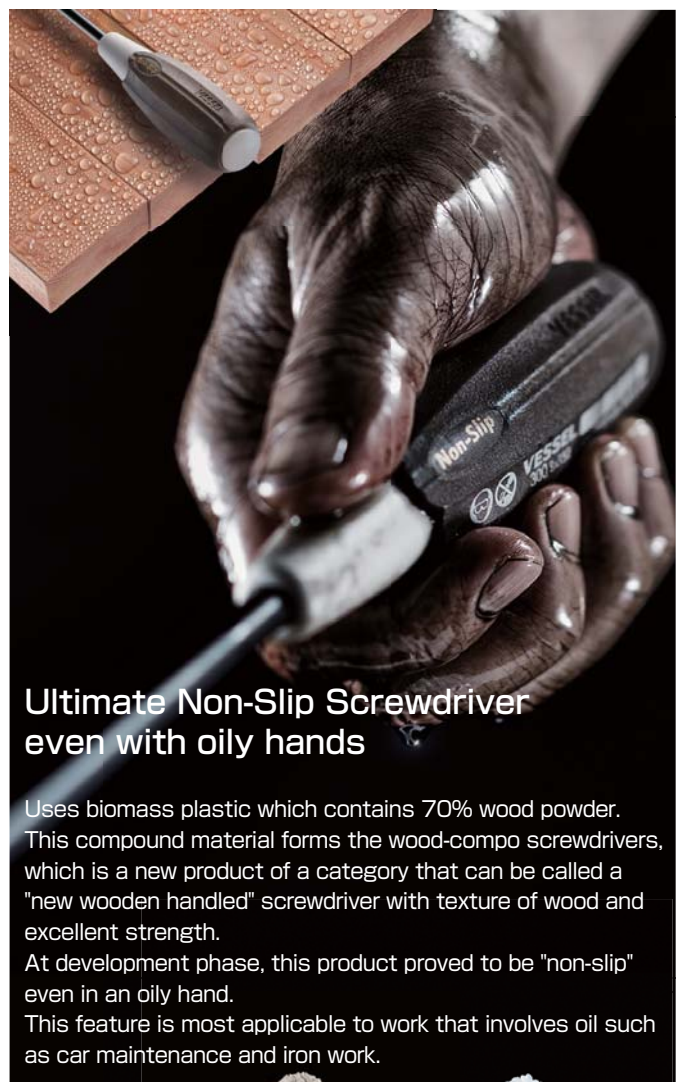

Ultimate Non-Slip Screwdriver even with oily hands

Uses biomass plastic which contains 70% wood powder. This compound material forms the wood-compo screwdrivers, which is a new product of a category that can be called a "new wooden handled" screwdriver with texture of wood and excellent strength. At development phase, this product proved to be "non-slip" even in an oily hand. This feature is most applicable to work that involves oil such as car maintenance and iron work.



One point

No. B-340TX

Wood-Compo TORX Screwdriver NEW PAT.



- Extraordinary non-slip grip; Secures working efficiency even with oily hands. Wood-composite resin, reproducing the natural material texture.
- Non-electrolytic plating, keeping the precise tip quality.
- Also good for tamper-proof TORX screws.



| No.B-340TX | T | W | H | L | SH | Inner (mm) | Outer (mm) | JAN (4907587) |
|------------|------|-----|-----|----|-----|------------|------------|---------------|
| T10H | 2.72 | 80 | 5.5 | 30 | 188 | 6 | 120 | 120081 |
| T15H | 3.26 | 80 | 5.5 | 30 | 188 | 6 | 120 | 120082 |
| T20H | 3.84 | 120 | 5.5 | 30 | 228 | 6 | 120 | 120083 |
| T25H | 4.40 | 120 | 6.4 | 32 | 236 | 6 | 60 | 120084 |
| T27H | 4.96 | 120 | 6.4 | 32 | 236 | 6 | 60 | 120085 |
| T30H | 5.49 | 120 | 8.0 | 35 | 246 | 6 | 60 | 120086 |
| T40H | 6.60 | 120 | 8.0 | 35 | 246 | 6 | 60 | 120087 |

TORX® is a registered trademark of Acument TM Intellectual Properties, LLC (USA). VESSEL has a manufacturing license in Japan and selling same to the world.

No. B-380NT

Wood-Compo Socket Screwdriver NEW PAT.



- Extraordinary non-slip grip; Secures working efficiency even with oily hands. Wood-composite resin, reproducing the natural material texture.
- Black oxide plated socket.
- Rust resistant chrome plating. Hexagonal shank for fastening with a wrench.

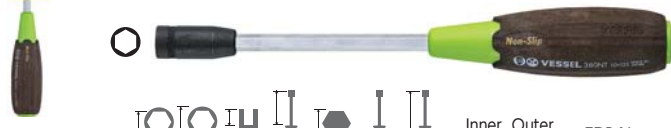

| No.B-380NT | W | H | L | SH | SH | Inner (mm) | Inner Ctn. | Outer Ctn. | EDP No. |
|-------------|-----|----|----|-----|-----|------------|------------|------------|---------|
| A/F 5 ×125 | 5 | 8 | 18 | 125 | 5.0 | 30.0 | 224 | 60 | 120091 |
| A/F 5.5×125 | 5.5 | 9 | 18 | 125 | 5.0 | 30.0 | 224 | 60 | 120092 |
| A/F 7 ×125 | 7 | 10 | 18 | 125 | 5.0 | 30.0 | 224 | 60 | 120093 |
| A/F 8 ×125 | 8 | 12 | 20 | 125 | 5.0 | 32.0 | 233 | 60 | 120094 |
| A/F 10×125 | 10 | 15 | 20 | 125 | 7.0 | 32.0 | 233 | 60 | 120095 |
| A/F 12×150 | 12 | 17 | 20 | 125 | 7.0 | 32.0 | 233 | 60 | 120096 |
| A/F 13×150 | 13 | 19 | 22 | 125 | 7.0 | 32.0 | 233 | 60 | 120097 |
| A/F 14×150 | 14 | 19 | 22 | 125 | 7.0 | 32.0 | 233 | 60 | 120098 |

No. B-370 Non-slip Tang-Thru Screwdrivers

- Unique Non-Slip finish that prevents slipping even if oil adheres on the grip.



- Tang-thru type with a large nut. Good for heavy duty work.
- The end of the handle has a color ring facilitates to distinguish the tip difference at a glance.



| No.B-370 | W | H | L | SH | SH | Inner (mm) | Inner Ctn. | Outer Ctn. | EDP No. |
|-----------|-------|-----|-----|------|------|------------|------------|------------|---------|
| ⊖ 5.5× 75 | 5.5 | 0.8 | 75 | 5.5 | 27.4 | 183 | 6 | 60 | 267590 |
| ⊖ 6 × 100 | 6.0 | 0.9 | 100 | 6.4 | 30.7 | 226 | 6 | 60 | 267591 |
| ⊖ 8 × 150 | 8.0 | 1.1 | 150 | 8.0 | 36.2 | 290 | 6 | 60 | 267592 |
| ⊕ 1 × 75 | ⊕No.1 | 75 | 5.5 | 27.4 | 183 | | 6 | 60 | 267593 |
| ⊕ 2 × 100 | ⊕No.2 | 100 | 6.4 | 30.7 | 226 | | 6 | 60 | 267594 |
| ⊕ 3 × 150 | ⊕No.3 | 150 | 8.0 | 36.2 | 290 | | 6 | 60 | 267595 |

HAND TOOLS

BITS & SOCKETS

ELECTRIC TOOLS

AIR TOOLS

STATIC SOLUTIONS

GASOLINE ENGINE TOOLS

No. 990

G-grip Screwdriver

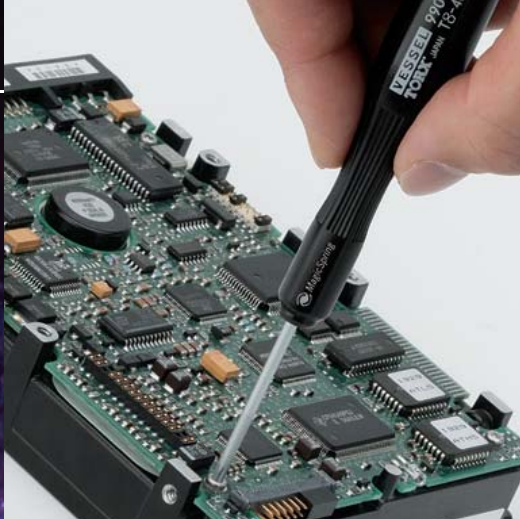

This precision screwdriver is perfect for the delicate screw tightening operations of precision work. Our high-precision, tip process conforms to JIS and JCIA standards. The ergonomic grips employed enable a smoother torque transfer.



No. 990

G-grip Screwdriver

Quick-turning screwdriver, taking advantage of the gravity force.

The perfect shape for high-precision work

The weight of the internal steel ball freely rotates the cap in the palm of the hand to provide the optimum grip position.



HAND TOOLS

BITS & SOCKETS

ELECTRIC TOOLS

AIR TOOLS

STATIC SOLUTIONS

GASOLINE ENGINE TOOLS

※The photograph is an image.

No. 990 G-grip Screwdriver PAT.

- The weight of the steel ball keeps the end cap in an optimum position for a grip.
 - Black point tip, fitting well screws.
 - Slotted tip is cut straight.



| No.990 | Bit Size | Length (mm) | Shank Dia (mm) | Tip Dia (mm) | Tip Length (mm) | Tip Width (mm) | Tip Thickness (mm) | Inner Ctn. | Outer Ctn. | EDP No. | |
|--------|----------|-------------|----------------|--------------|-----------------|----------------|--------------------|------------|------------|---------|--------|
| ⊖ | 1.8 × 50 | 1.8 | 0.25 | 50 | 2.5 | 16 | 21 | 148 | 12 | 240 | 125901 |
| ⊖ | 2.5 × 75 | 2.5 | 0.3 | 75 | 2.5 | 16 | 21 | 173 | 12 | 240 | 125902 |
| ⊖ | 3 × 100 | 3 | 0.5 | 100 | 3.0 | 16 | 21 | 198 | 12 | 240 | 125903 |
| ⊖ | 4 × 100 | 4 | 0.6 | 100 | 4.0 | 16 | 21 | 198 | 12 | 240 | 125904 |
| ⊖ | 5 × 100 | 5 | 0.8 | 100 | 5.0 | 30 | 38 | 215 | 6 | 60 | 125905 |
| ⊕ | 00 × 75 | ⊕No.00 | 75 | 2.5 | 16 | 21 | 173 | | 12 | 240 | 125911 |
| ⊕ | 0 × 100 | ⊕No.0 | 100 | 3.0 | 16 | 21 | 198 | | 12 | 240 | 125912 |
| ⊕ | 1 × 100 | ⊕No.1 | 100 | 3.0 | 30 | 38 | 215 | | 6 | 60 | 125913 |
| ⊕ | 2 × 100 | ⊕No.2 | 100 | 5.0 | 30 | 38 | 215 | | 6 | 60 | 125914 |

No. 9902/9903 3-Piece Micro Screwdriver Set

- 2 types recommended to precision fields.
- Set of frequently used sizes.
- For adjustment and repair of precision device, electric device, glasses, watches, etc.



| Model No. | Set content | Package size (mm) | Inner Ctn. | Outer Ctn. | EDP No. |
|-----------|---------------------------------|-------------------|------------|------------|---------|
| 9902 | No.9900 ⊕00×75, ⊕0×100, ⊖1.8×50 | 235×70×15 | 5 | 30 | 125636 |
| 9903 | No.9900 ⊕00×75, ⊖2.5×75, ⊖3×100 | 235×70×15 | 5 | 30 | 125637 |

No. 990TX G-grip TORX Screwdriver PAT.

- The weight of the steel ball keeps the end cap in an optimum position for a grip.
 - A special precision spring is welded to the tip by laser, enabling the screwdriver to catch a TORX screw firmly by spring action.



| No.990TX | Bit Size | Length (mm) | Shank Dia (mm) | Tip Dia (mm) | Tip Length (mm) | Tip Width (mm) | Tip Thickness (mm) | Inner Ctn. | Outer Ctn. | EDP No. |
|-------------|----------|-------------|----------------|--------------|-----------------|----------------|--------------------|------------|------------|---------|
| | T3 × 40 | 1.13 | 40 | 2.5 | 16 | 21 | 138 | 12 | 240 | 125921 |
| | T5 × 40 | 1.42 | 40 | 2.5 | 16 | 21 | 138 | 12 | 240 | 125923 |
| MagicSpring | T6 × 40 | 1.69 | 40 | 2.5 | 16 | 21 | 138 | 12 | 240 | 125924 |
| MagicSpring | T8 × 40 | 2.3 | 40 | 2.5 | 16 | 21 | 138 | 12 | 240 | 125926 |
| MagicSpring | T9 × 40 | 2.48 | 40 | 4.0 | 16 | 21 | 138 | 12 | 240 | 125927 |
| MagicSpring | T10 × 80 | 2.72 | 80 | 4.0 | 30 | 38 | 195 | 6 | 60 | 125928 |
| MagicSpring | T15 × 80 | 3.26 | 80 | 5.5 | 30 | 38 | 195 | 6 | 60 | 125929 |
| MagicSpring | T20 × 80 | 3.84 | 80 | 5.5 | 30 | 38 | 195 | 6 | 60 | 125930 |

TORX® is a registered trademark of Acument TM Intellectual Properties, LLC (USA). VESSEL has a manufacturing license in Japan and selling same to the world.

No. 9900 Micro Screwdriver

- Equipped with a cap for fast turning on the grip.
- Remarkably highly precise black point tip.



| No.9900 | Bit Size | Length (mm) | Shank Dia (mm) | Tip Dia (mm) | Tip Length (mm) | Tip Width (mm) | Tip Thickness (mm) | Inner Ctn. | Outer Ctn. | EDP No. |
|---------|----------|-------------|----------------|--------------|-----------------|----------------|--------------------|------------|------------|---------|
| ⊖ | 1.8 × 50 | 1.8 | 0.25 | 50 | 2.5 | 10 | 145 | 10 | 120 | 125621 |
| ⊖ | 2.5 × 75 | 2.5 | 0.35 | 75 | 2.5 | 10 | 170 | 10 | 120 | 125622 |
| ⊖ | 3 × 100 | 3 | 0.45 | 100 | 3 | 10 | 195 | 10 | 120 | 125623 |
| ⊖ | 3 × 150 | 3 | 0.45 | 150 | 3 | 10 | 245 | 10 | 120 | 125624 |
| ⊕ | 00 × 75 | ⊕No.00 | 75 | 2.5 | 10 | 170 | | 10 | 120 | 125625 |
| ⊕ | 0 × 100 | ⊕No.0 | 100 | 3 | 10 | 195 | | 10 | 120 | 125626 |
| ⊕ | 0 × 150 | ⊕No.0 | 150 | 3 | 10 | 245 | | 10 | 120 | 125627 |

One point

Features of the precision tip

Precisely-finished tip-end good for minuscule screws No.990 / No.9900

A deep recessed area can also be accessed by the thin shank!

No.990

6mm hole, M3 round head screw, and screw head dia. of φ5.5 mm

Two-step flat shape, enabling the tip to fit into a screw

No.990

1.8 / 2.5 / 3 / 4 / 5

StepFlat

Catches a TORX screw

A special-shape spring is welded to the tip by laser.

No.990TX

T6 / T8 / T9 / T10 / T15 / T20

MagicSpring

TORX® is a registered trademark of Acument TM Intellectual Properties, LLC (USA). VESSEL has a manufacturing license in Japan and selling same to the world.

HAND TOOLS

BITS & SOCKETS

ELECTRIC TOOLS

AIR TOOLS

STATIC SOLUTIONS

GASOLINE ENGINE TOOLS

No. TD-51 Precision Micro Screwdriver

- The main body is made of stainless steel (the end cap is made of resin).
- For assembly, repair, and disassembly of precision devices, cameras, watches, glasses, etc.

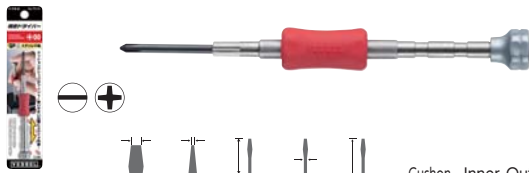

| No. TD-51 | Tip | Tip (mm) | Length (mm) | Tip Dia (mm) | Tip Dia (mm) | Cushion Grip color | Inner Ctn. | Outer Ctn. | EDP No. | |
|-----------|--------|----------|-------------|--------------|--------------|--------------------|------------|------------|---------|--------|
| ⊖0.7 | | 0.7 | 0.15 | 10 | 0.7 | 90 | Purple | 10 | 100 | 251350 |
| ⊖0.9 | | 0.9 | 0.2 | 10 | 0.9 | 90 | Green | 10 | 100 | 251351 |
| ⊖1.2 | | 1.2 | 0.25 | 10 | 1.2 | 90 | Blue | 10 | 100 | 251352 |
| ⊖1.8 | | 1.8 | 0.3 | 20 | 1.8 | 100 | Black | 10 | 100 | 251353 |
| ⊖2.3 | | 2.3 | 0.35 | 22 | 2.3 | 102 | Purple | 10 | 100 | 251354 |
| ⊖3.0 | | 3.0 | 0.4 | 26 | 3.0 | 106 | Red | 10 | 100 | 251355 |
| ⊖3.5 | | 3.5 | 0.5 | 28 | 3.5 | 108 | Yellow | 10 | 100 | 251356 |
| ⊕00 | ⊕No.00 | 24 | 2.4 | 104 | | | Red | 10 | 100 | 251357 |
| ⊕0 | ⊕No.0 | 26 | 3.0 | 106 | | | Yellow | 10 | 100 | 251358 |
| ⊕1 | ⊕No.1 | 26 | 3.0 | 106 | | | Green | 10 | 100 | 251359 |

Package size...160×35×14mm

No. TD-52 Precision Nutdriver

- The main body is made of stainless steel (the end cap is made of resin).
- For assembly, repair, and disassembly of precision devices, spacer, toys, etc.

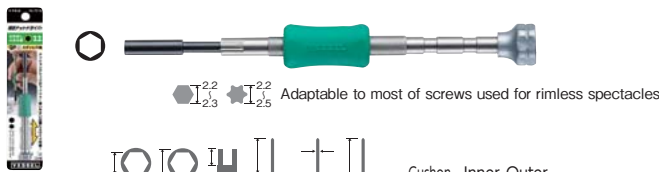

| No. TD-52 | Tip | Tip (mm) | Length (mm) | Tip Dia (mm) | Tip Dia (mm) | Cushion Grip color | Inner Ctn. | Outer Ctn. | EDP No. | | |
|-----------|-----|----------|-------------|--------------|--------------|--------------------|------------|------------|---------|-----|--------|
| 2.2 | | — | 4.0 | 12 | 25 | 3.0 | 105 | Green | 10 | 100 | 251361 |
| A/F 3.0 | | 3.0 | 5.0 | 7 | 25 | 3.0 | 105 | Blue | 10 | 100 | 251362 |
| A/F 4.0 | | 4.0 | 6.0 | 9 | 25 | 3.0 | 105 | Black | 10 | 100 | 251363 |
| A/F 4.5 | | 4.5 | 6.5 | 10 | 25 | 3.0 | 105 | Purple | 10 | 100 | 251364 |
| A/F 5.0 | | 5.0 | 7.0 | 11 | 25 | 3.0 | 105 | Red | 10 | 100 | 251365 |
| A/F 5.5 | | 5.5 | 8.0 | 10 | 25 | 3.0 | 105 | Yellow | 10 | 100 | 251366 |

Package size...160×35×14mm

No. TD-53 Precision Hex. Driver

- The main body is made of stainless steel (the end cap is made of resin).
- For assembly, repair, and disassembly of precision devices, toys, etc.

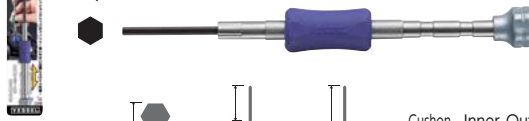

| No. TD-53 | Tip | Tip (mm) | Length (mm) | Tip Dia (mm) | Tip Dia (mm) | Cushion Grip color | Inner Ctn. | Outer Ctn. | EDP No. |
|-----------|-----|----------|-------------|--------------|--------------|--------------------|------------|------------|---------|
| H 0.89 | | 0.89 | 18 | 98 | | Green | 10 | 100 | 251371 |
| H 1.27 | | 1.27 | 18 | 98 | | Blue | 10 | 100 | 251372 |
| H 1.5 | | 1.5 | 18 | 98 | | Black | 10 | 100 | 251373 |
| H 2.0 | | 2.0 | 24 | 104 | | Purple | 10 | 100 | 251374 |
| H 2.5 | | 2.5 | 24 | 104 | | Yellow | 10 | 100 | 251375 |

Package size...160×35×14mm

No. TD-54 Watch Band Pin Punch

- The main body is made of stainless steel (the end cap is made of resin).
- For adjustment of the watch band.

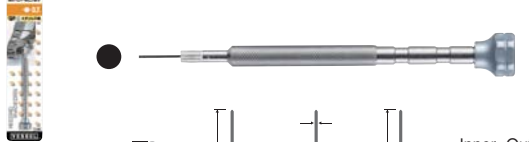

| No. TD-54 | Tip | Tip (mm) | Length (mm) | Tip Dia (mm) | Inner Ctn. | Outer Ctn. | EDP No. | |
|-----------|-----|----------|-------------|--------------|------------|------------|---------|--------|
| 0.7 | | 0.7 | 10 | 0.7 | 90 | 10 | 100 | 251380 |

Package size...160×35×14mm

No. TD-55/56/57/58 Precision Screwdriver Set

- The main body is made of stainless steel (the end cap is made of resin).
- Provided in a portable transparent case.



| Model No. | Model Name | Set content | Package size (mm) | Inner Ctn. | EDP No. |
|-----------|---------------------------|-------------------------------------|-------------------|------------|---------|
| TD-55 | Precision Screwdriver Set | ⊖0.9, ⊖1.2, ⊖1.8, ⊖2.3, ⊖3.0, ⊖3.5 | 140×86×20 | 10 | 251381 |
| TD-56 | Precision Screwdriver Set | ⊖0.9, ⊖1.2, ⊖1.8, ⊖2.3, ⊕00, ⊕0 | 140×86×20 | 10 | 251382 |
| TD-57 | Precision Nut driver Set | 2.2, ⊖3.0, ⊖4.0, ⊖4.5, ⊖5.0, ⊖5.5 | 140×86×20 | 10 | 251383 |
| TD-58 | Precision Hex.driver Set | ●0.89, ●1.27, ●1.5, ●2.0, ●2.5, ⊕00 | 140×86×20 | 10 | 251384 |

No. 9000 Ceramic Adjusters

- Uses a zirconia ceramics tip, non-inductive magnetic substance.
- Optimum for coil and trimmer adjustments.
- For the adjustment of electronic parts, such as audio instruments, computers, telecommunication devices, electronics components, and electric components.

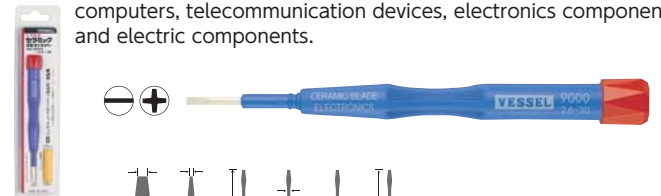

| No. 9000 | Tip | Tip (mm) | Length (mm) | Tip Dia (mm) | Tip Dia (mm) | End cap color | Inner Ctn. | Outer Ctn. | EDP No. | | |
|----------|-----------|----------|-------------|--------------|--------------|---------------|------------|------------|---------|----|--------|
| ⊖0.9×30 | | 0.9 | 0.4 | 30 | 1.8 | 10 | 125 | Green | 10 | 60 | 125641 |
| ⊖1.3×30 | | 1.3 | 0.4 | 30 | 1.8 | 10 | 125 | White | 10 | 60 | 125642 |
| ⊖1.8×30 | | 1.8 | 0.4 | 30 | 1.8 | 10 | 125 | Yellow | 10 | 60 | 125643 |
| ⊖2.6×30 | | 2.6 | 0.4 | 30 | 2.6 | 10 | 125 | Red | 10 | 60 | 125644 |
| ⊖3.4×15 | | 3.4 | 0.5 | 15 | 3.4 | 10 | 115 | Black | 10 | 60 | 125645 |
| ⊕0 ×30 | ⊕No.0 | 30 | 2.6 | 10 | 125 | Navy blue | 10 | 60 | 125646 | | |
| ⊕1.7×30 | ⊕Width1.7 | 30 | 2.6 | 10 | 125 | Lilac | 10 | 60 | 125647 | | |

Package size...190×45×14mm

No. CA Individual Ceramic Blades / Ceramic Blade Adapters

- Blade for automatic adjuster. ●Made of zirconia ceramics, offering high durability.
- For the adjustment of electronic parts, such as audio instruments, computers, telecommunication devices and electronic components.

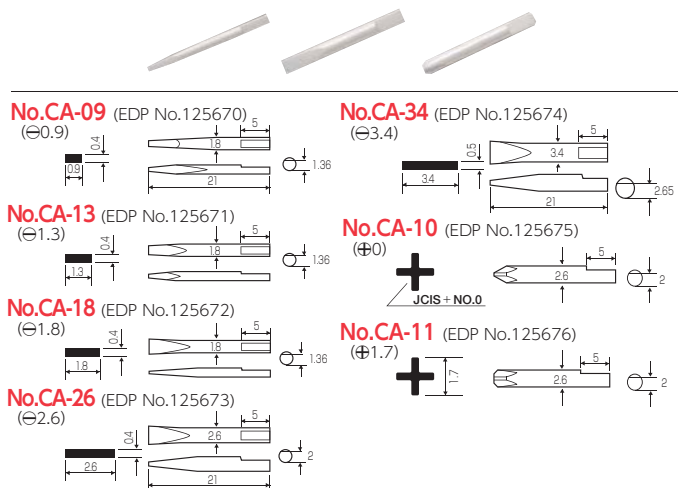

| No. CA | Tip | Tip (mm) | Length (mm) | Tip Dia (mm) | Tip Dia (mm) | EDP No. | |
|-----------|--------|----------|-------------|--------------|--------------|---------|--------|
| No. CA-09 | (⊖0.9) | 0.9 | 0.4 | 30 | 1.8 | 10 | 125670 |
| No. CA-34 | (⊖3.4) | 3.4 | 0.5 | 15 | 3.4 | 10 | 125674 |
| No. CA-13 | (⊖1.3) | 1.3 | 0.4 | 30 | 1.8 | 10 | 125671 |
| No. CA-10 | (⊕0) | 30 | 2.6 | 10 | 125 | 10 | 125675 |
| No. CA-18 | (⊖1.8) | 1.8 | 0.4 | 30 | 1.8 | 10 | 125672 |
| No. CA-11 | (⊕1.7) | 30 | 2.6 | 10 | 125 | 10 | 125676 |
| No. CA-26 | (⊖2.6) | 2.6 | 0.4 | 30 | 2.6 | 10 | 125673 |

Inner Ctn.:10pcs

No. TD-6800 Series Ratchet Screwdriver



This functionally enhanced screwdriver enables screw tightening by simple repeated wrist movements.

Improved gear strength combined with our unique ratchet design makes these screwdrivers suitable for the most strenuous tightening jobs.

HAND TOOLS

BITS & SOCKETS

ELECTRIC TOOLS

AIR TOOLS

STATIC SOLUTIONS

GASOLINE ENGINE TOOLS



No. TD-6804MG Ratchet Screwdriver

Newly developed 72 gear ratchet realizes smooth rotation. You can work by one hand, without grasping over again.

Ratchet series optimal for a confined area

| | Flexible | Plate Ratchet | Screw catcher | Stubby | Driver | Power |
|---------------------------------|-------------|-------------------------------------|--------------------|-------------|----------------|------------------------------------|
| At a corner edge | | | | | | |
| In a narrow area | | | | | | |
| In a deep recessed area | | | | | | |
| For torque retaining tightening | | | | | | |
| | TD-6700FX-4 | TD-74/75/76/77/78/79 TD-70/71/72 | TD-73MC TX-12MC | TD-6700W-23 | TD-6800 Series | S-13 |
| | | TD-74/75/76/77/78/79 | | TD-6700W-23 | TD-6800 Series | TD-80 S-12/13 TD-81R/81G/81B |

No. TD-6804MG Ratchet Screwdriver (4-pc bit set) **NEW**

- Smoothly click feeling realized by rotating angle of 5° and 72 gears. High strength accomplished by 2 nails supporting the ratchet gear. It can be used for final tightening work.
- The handle is made out of oil-resistance cellulose acetate resin.
- Easy to carry around with cassette type bit storage inside the handle.
- Magnetic bits can be replaced with one-touch.
- Bit insertion part ●6.35mm.



| Set content | | | |
|-------------------|--------------------------|------------|---------|
| Body | length 177mm dia. 28.5mm | | |
| Bits | ⌀1, ⌀2, ⌀3, ⌀6 ×25.4mm | | |
| Package size (mm) | Inner Ctn. | Outer Ctn. | EDP No. |
| 235×80×29 | 5 | 30 | 247022 |

No. TD-6808MG Ratchet Screwdriver (8-pc bit set) **NEW**

- Smoothly click feeling realized by rotating angle of 5° and 72 gears. High strength accomplished by 2 nails supporting the ratchet gear. It can be used for final tightening work.
- The handle is made out of oil-resistance cellulose acetate resin.
- Easy to carry around with cassette type bit storage inside the handle.
- Stores 8 types of bits including HEX bit. Magnetic bits can be replaced with one-touch.
- Bit insertion part ●6.35mm.



| Set content | | | |
|-------------------|--|------------|---------|
| Body | length 177mm dia. 28.5mm | | |
| Bits | ⌀1, ⌀2, ⌀3, ⌀6, H2.5, H3, H4, H5 ×25.4mm | | |
| Package size (mm) | Inner Ctn. | Outer Ctn. | EDP No. |
| 235×80×29 | 5 | 30 | 247023 |

No. TD-6808TX Ratchet Screwdriver TORX (8-pc bit set) **NEW**

- Smoothly click feeling realized by rotating angle of 5° and 72 gears. High strength accomplished by 2 nails supporting the ratchet gear. It can be used for final tightening work.
- The handle is made out of oil-resistance cellulose acetate resin.
- Easy to carry around with cassette type bit storage inside the handle.
- Stores 8 types of bits including TORX bit. Magnetic bits can be replaced with one-touch.
- Bit insertion part ●6.35mm.



| Set content | | | |
|-------------------|--|------------|---------|
| Body | length 177mm dia. 28.5mm | | |
| Bits | ⌀2, ⌀3, T10H, T15H, T20H, T25H, T30H, T40H ×25.4mm | | |
| Package size (mm) | Inner Ctn. | Outer Ctn. | EDP No. |
| 235×80×29 | 5 | 30 | 247024 |

TORX® is a registered trademark of Acument TM Intellectual Properties, LLC (USA). VESSEL has a manufacturing license in Japan and selling same to the world.

No. TD-6816MG Ratchet Screwdriver (16-pc bit set) **NEW**

- Smoothly click feeling realized by rotating angle of 5° and 72 gears. High strength accomplished by 2 nails supporting the ratchet gear. It can be used for final tightening work.
- The handle is made out of oil-resistance cellulose acetate resin.
- Easy to carry around with cassette type bit storage inside the handle.
- 16 types of bits to adapt to various types of work. Magnetic bits can be replaced with one-touch.
- Bit insertion part ●6.35mm.



| Set content | | | |
|-------------------|--|------------|---------|
| Body | length 177mm dia. 28.5mm | | |
| Bits | ⌀1, ⌀2, ⌀3, ⌀6, H2, H2.5, H3, H4, H5, T10H, T15H, T20H, T25H, T27H, T30H, T40H ×25.4mm | | |
| Package size (mm) | Inner Ctn. | Outer Ctn. | EDP No. |
| 235×90×29 | 5 | 30 | 247025 |

TORX® is a registered trademark of Acument TM Intellectual Properties, LLC (USA). VESSEL has a manufacturing license in Japan and selling same to the world.

No. TD-6700W-23 Ratchet Stubby Screwdriver **NEW**

- Improves workability in cramped spaces! Stubby type that fits in your hand.
- Smoothly click feeling realized by rotating angle of 5° and 72 gears. High strength accomplished by 2 nails supporting the ratchet gear. It can be used for final tightening work.
- The handle is made out of oil-resistance cellulose acetate resin.
- Ball-lock bits can be replaced with one-touch.
- Bit insertion part ●6.35mm.



| Set content | | | |
|-------------|-----------------------|-------------------|-----------|
| Body | length 77mm dia. 35mm | Package size (mm) | 135×70×40 |
| Bits | ⌀2 / ⌀3 ×35mm | Inner Ctn. | 10 |
| | | Outer Ctn. | 60 |
| | | EDP No. | 247026 |

No. TD-6700FX-4 Ratchet Stubby Screwdriver with Flexible Shaft **NEW**

- Improves workability in cramped spaces! Stubby type that fits in your hand.
- Smoothly click feeling realized by rotating angle of 5° and 72 gears. High strength accomplished by 2 nails supporting the ratchet gear. It can be used for final tightening work.
- The handle is made out of oil-resistance cellulose acetate resin.
- Ball-lock bits can be replaced with one-touch.
- Bit insertion part ●6.35mm.



| Set content | | | |
|-------------------------------|-----------------------|-------------------|-----------|
| Body | length 77mm dia. 35mm | Package size (mm) | 235×80×40 |
| Bits | ⌀1, ⌀2, ⌀4, ⌀6 ×33mm | Inner Ctn. | 5 |
| Flexible Shaft (length 165mm) | | Outer Ctn. | 30 |
| | | EDP No. | 247027 |

No. TD-81 Power Ratchet Screwdriver

- Ratchet fine feed enables to fasten with a little wrist movement.
- Ideal ratchet mechanism for sufficient final tightening.
- 2 double-ended bits (different size combination) can be stored within the handle.
- Bit insertion part ϕ 6.35mm

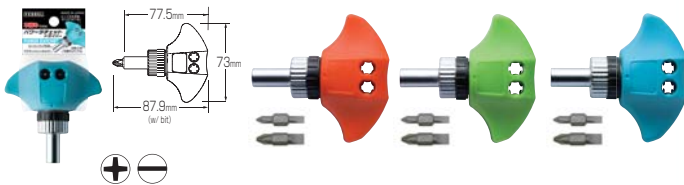

| Model No. | Color | Bits | Package size (mm) | Inner Ctn. | EDP No. |
|-----------|-------|--|-----------------------------|------------|---------|
| TD-81R | Red | ϕ 1/ ϕ 4, ϕ 2/ ϕ 6 \times 25.4 | 115 \times 73 \times 34 | 10 | 250081 |
| TD-81G | Green | ϕ 1/ ϕ 4, ϕ 2/ ϕ 6 \times 25.4 | 115 \times 73 \times 34 | 10 | 250082 |
| TD-81B | Blue | ϕ 1/ ϕ 4, ϕ 2/ ϕ 6 \times 25.4 | 115 \times 73 \times 34 | 10 | 250083 |

No. TD-80 T-Bar Ratchet Screwdriver

- Ratchet driving mechanism allows you to tighten a screw without adjusting your grip.
- Bit insertion part ϕ 6.35mm



Set content

| | |
|-----------|--|
| Body | T-bar ratchet screwdriver length 78mm dia. 73mm |
| Bits | ϕ 1, ϕ 2, ϕ 3, ϕ 4, ϕ 6 \times 25.4mm |
| Accessory | Bit belt holder |

| Package size (mm) | Outer Ctn. | EDP No. |
|------------------------------|------------|---------|
| 170 \times 105 \times 28 | 40 | 250080 |



No. S-13 Handy Tool Set

- Easy-to-use tool sets for fastening jobs around the house.
- Optimum for work at a corner or place with obstacles!
- Bit insertion part ϕ 6.35mm

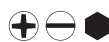

Set content

| | |
|------------|--|
| Body | T-bar ratchet screwdriver length 78mm dia. 73mm |
| Short Bits | ϕ 1, ϕ 2, ϕ 3, ϕ 4, ϕ 6, H2, H2.5, H3, H4, H5, H6 \times 25.4mm |
| Accessory | Magnetic Bit holder (length 115mm) Flexible shank (length 145mm) |

| Package size (mm) | Outer Ctn. | EDP No. |
|------------------------------|------------|---------|
| 240 \times 143 \times 45 | 10 | 250003 |



No. 2200 Ball Ratchet Screwdriver NEW

- With 36-teeth gear ratchet to realize comfortable operation with fine tuning.
- Shank cover prevents short circuits. Thin shank is convenient for operating on terminal blocks.



- Shank uses bit materials, fully hardened. Replacement shank is available as option.



No.2200

| | | | | | | Inner Ctn. | Outer Ctn. | EDP No. | |
|--------------------------|-------------|-----|-----|-----|-----|------------|------------|---------|--------|
| \ominus 6 \times 100 | 6.0 | 0.8 | 100 | 6.0 | 41 | 200 | 6 | 60 | 125395 |
| \ominus 6 \times 150 | 6.0 | 0.8 | 150 | 6.0 | 41 | 250 | 6 | 60 | 125396 |
| \oplus 2 \times 100 | ϕ No.2 | 100 | 6.0 | 41 | 200 | | 6 | 60 | 125345 |
| \oplus 2 \times 150 | ϕ No.2 | 150 | 6.0 | 41 | 250 | | 6 | 60 | 125346 |
| \oplus 3 \times 150 | ϕ No.3 | 150 | 6.0 | 41 | 250 | | 6 | 60 | 125347 |

⚠ Electric insulation is not guaranteed. For safety purposes, shut off power before use.

No. 2200B Ball Ratchet Screwdriver Reversible Blade NEW

- Shank uses bit materials, fully hardened.
- Replacement blade; can be replaced by pulling out the ball-grip part of No.2200.



No.2200B

| | | | | | | Inner Ctn. | Outer Ctn. | EDP No. |
|--------------------------|-------------|-----|-----|-----|-----|------------|------------|---------|
| \ominus 6 \times 100 | 6.0 | 0.8 | 100 | 6.0 | 158 | 6 | 60 | 125397 |
| \ominus 6 \times 150 | 6.0 | 0.8 | 150 | 6.0 | 208 | 6 | 60 | 125398 |
| \oplus 2 \times 100 | ϕ No.2 | 100 | 6.0 | 158 | | 6 | 60 | 125348 |
| \oplus 2 \times 150 | ϕ No.2 | 150 | 6.0 | 208 | | 6 | 60 | 125349 |
| \oplus 3 \times 150 | ϕ No.3 | 150 | 6.0 | 208 | | 6 | 60 | 125350 |

One point

Shanks are detachable from the ratchet part
Reversible blade can be replaced with one-touch.

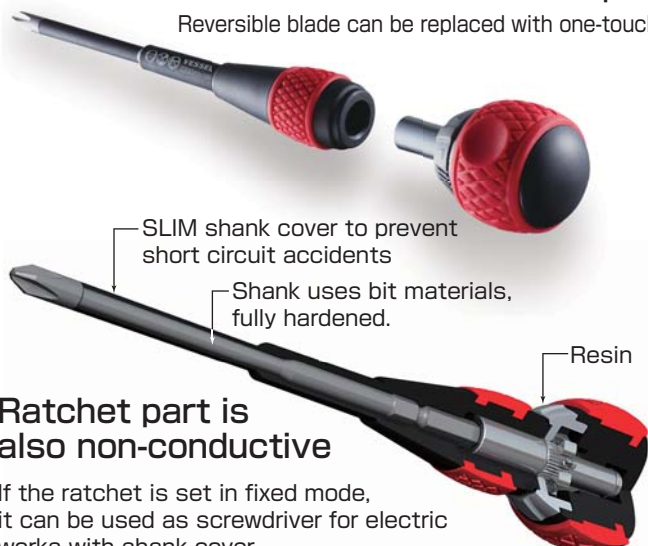

Ratchet part is also non-conductive

If the ratchet is set in fixed mode, it can be used as screwdriver for electric works with shank cover. It is most suitable for working on distribution boards.

HAND TOOLS

BITS & SOCKETS

ELECTRIC TOOLS

AIR TOOLS

STATIC SOLUTIONS

GASOLINE ENGINE TOOLS

No. TD-74 "PETA-RACHE" Flat-shaped Ratchet Screwdriver (straight type)

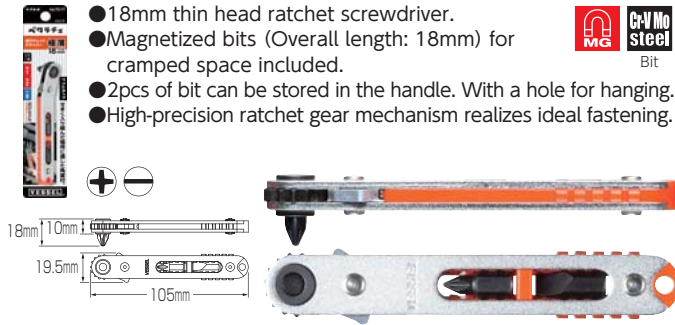

| Model No. | Set content | Package size (mm) | Inner Ctn. | EDP No. |
|-----------|--|-------------------|------------|---------|
| TD-74 | Flat-shaped Ratchet Screwdriver (Straight type) Bits $\oplus 1, \oplus 2, \ominus 6 \times 18\text{mm}$ | 160x35x21 | 10 | 250074 |

No. TD-77 "PETA-RACHE" Flat-shaped Ratchet Screwdriver (bent-up type)

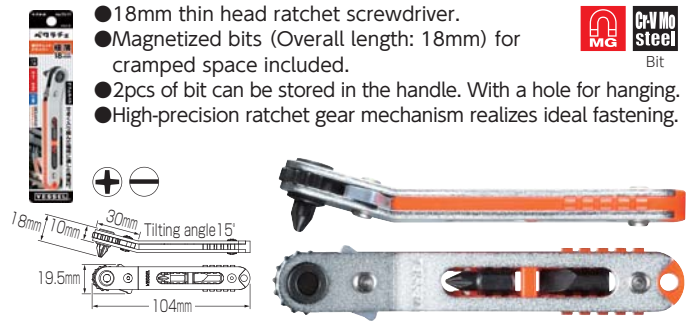

| Model No. | Set content | Package size (mm) | Inner Ctn. | EDP No. |
|-----------|--|-------------------|------------|---------|
| TD-77 | Flat-shaped Ratchet Screwdriver (Angled type) Bits $\oplus 1, \oplus 2, \ominus 6 \times 18\text{mm}$ | 160x35x21 | 10 | 250077 |

No. TD-75 "PETA-RACHE" Flat-shaped Ratchet Screwdriver (straight type)

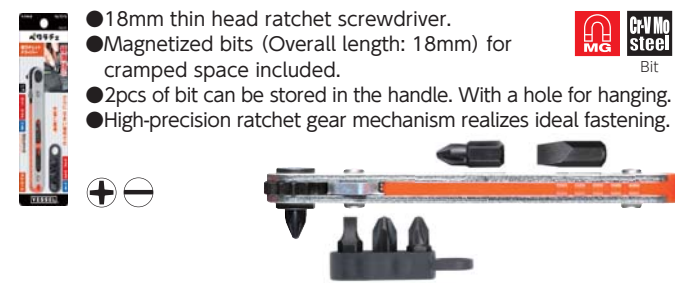

| Model No. | Set content | Package size (mm) | Inner Ctn. | EDP No. |
|-----------|---|-------------------|------------|---------|
| TD-75 | Flat-shaped Ratchet Screwdriver (Straight type) Bits $\oplus 1, \oplus 2, \oplus 2, \oplus 3, \ominus 4, \ominus 6 \times 18\text{mm}$ Bit holder | 160x50x21 | 10 | 250075 |

No. TD-78 "PETA-RACHE" Flat-shaped Ratchet Screwdriver (bent-up type)



| Model No. | Set content | Package size (mm) | Inner Ctn. | EDP No. |
|-----------|---|-------------------|------------|---------|
| TD-78 | Flat-shaped Ratchet Screwdriver (Angled type) Bits $\oplus 1, \oplus 2, \oplus 2, \oplus 3, \ominus 4, \ominus 6 \times 18\text{mm}$ Bit holder | 160x50x21 | 10 | 250078 |

No. TD-76 "PETA-RACHE" Flat-shaped Ratchet Screwdriver (straight type)



| Model No. | Set content | Package size (mm) | Inner Ctn. | EDP No. |
|-----------|--|-------------------|------------|---------|
| TD-76 | Flat-shaped Ratchet Screwdriver (Straight type) Bits $\oplus 1, \oplus 2, \oplus 2, \oplus 3, \ominus 4, \ominus 6, \text{H}2.5, \text{H}3, \text{H}4, \text{H}5, \text{H}6 \times 18\text{mm}$ Bit holder | 160x50x21 | 10 | 250076 |

No. TD-79 "PETA-RACHE" Flat-shaped Ratchet Screwdriver (bent-up type)



| Model No. | Set content | Package size (mm) | Inner Ctn. | EDP No. |
|-----------|--|-------------------|------------|---------|
| TD-79 | Flat-shaped Ratchet Screwdriver (Angled type) Bits $\oplus 1, \oplus 2, \oplus 2, \oplus 3, \ominus 4, \ominus 6, \text{H}2.5, \text{H}3, \text{H}4, \text{H}5, \text{H}6 \times 18\text{mm}$ Bit holder | 160x50x21 | 10 | 250079 |

No. TD-BS "PETA-RACHE" 18mm replacement bits

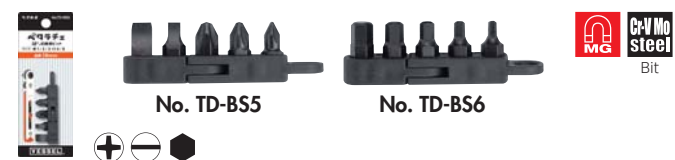

| Model No. | Set content | Package size (mm) | Inner Ctn. | EDP No. |
|-----------|---|-------------------|------------|---------|
| TD-BS5 | Bits $\oplus 1, \oplus 2, \oplus 3, \ominus 4, \ominus 6 \times 18\text{mm}$ Bit holder | 120x40x23 | 10 | 251304 |
| TD-BS6 | Bits $\text{H}2.5, \text{H}3, \text{H}4, \text{H}5, \text{H}6 \times 18\text{mm}$ Bit holder | 120x40x23 | 10 | 251305 |

No. TD-70 Flat Plate Ratchet Screwdriver Set



| Set content | | Package size (mm) | Inner Ctn. | EDP No. |
|-------------|---|-------------------|------------|---------|
| Body | Plate ratchet screwdriver | | | |
| Bits | Φ1, Φ2, Φ3, Φ4, Φ6, H2.5, H3, H4, H5, H6×25.4mm | | | |
| Accessory | Bit belt holder | | | |

No. TD-73MC Plate Ratchet Screw Catcher



| Set content | | Package size (mm) | Inner Ctn. | EDP No. |
|-------------|--|-------------------|------------|---------|
| Body | Plate ratchet screwdriver | | | |
| Bits | Φ1, Φ2, Φ3, Φ4, Φ6, H 2.5, 3, 4, 5, 6×25.4mm | | | |
| Accessory | Magnetic Screw Holder Bit belt holder | | | |

No. TD-71 Flat Plate Ratchet Screwdriver

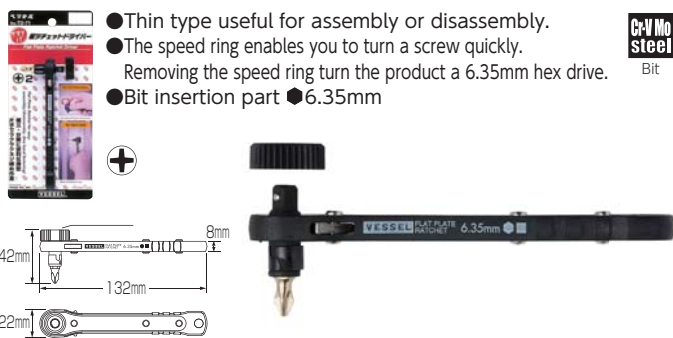

| Set content | | Package size (mm) | Inner Ctn. | EDP No. |
|-------------|---------------------------|-------------------|------------|---------|
| Body | Plate ratchet screwdriver | | | |
| Bit | Φ2×25.4mm | | | |

No. TX-12MC Plate Ratchet/Magnetic Screw Catcher (TORX)

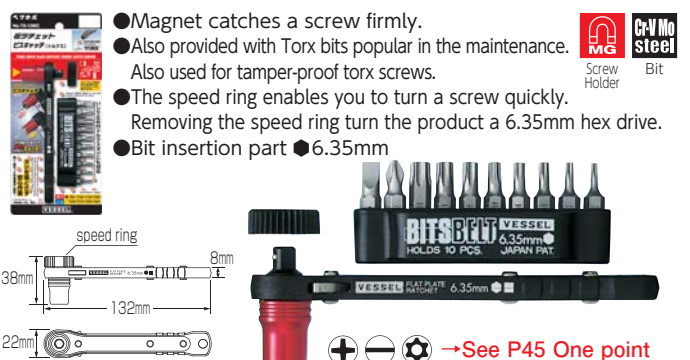

| Set content | | Package size (mm) | Inner Ctn. | EDP No. |
|-------------|--|-------------------|------------|---------|
| Body | Plate ratchet screwdriver | | | |
| Bits | T8H, T10H, T15H, T20H, T25H, T27H, T30H, T40H, Φ2, Φ6×25.4mm | | | |
| Accessory | Magnetic Screw Holder Bit belt holder | | | |

No. TD-72 Flat Plate Ratchet Screwdriver Set

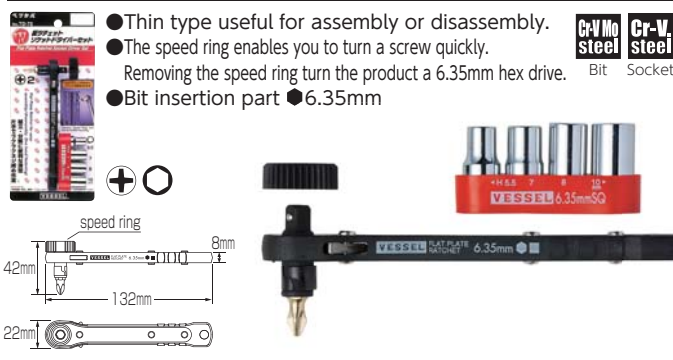

| Set content | | Package size (mm) | Inner Ctn. | EDP No. |
|-------------|---------------------------|-------------------|------------|---------|
| Body | Plate ratchet screwdriver | | | |
| Bit | Φ2×25.4mm | | | |
| Socket | A/F 5.5, 7, 8, 10×26mm | | | |
| Accessory | Socket holder | | | |

No. TX-11 Plate Ratchet TORX Set

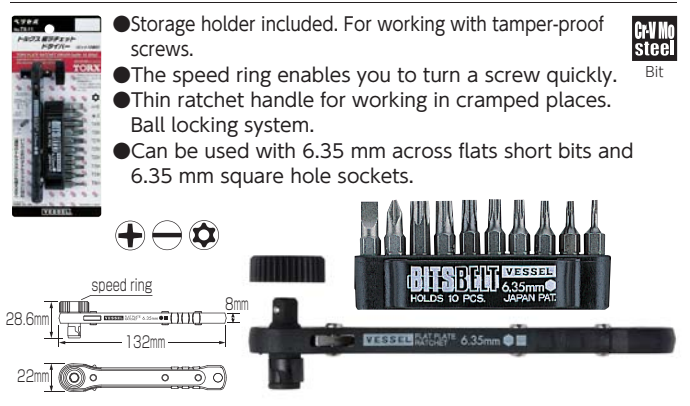





| Set content | | Package size (mm) | Inner Ctn. | EDP No. |
|-------------|--|-------------------|------------|---------|
| Body | Plate ratchet screwdriver | | | |
| Bits | T8H, T10H, T15H, T20H, T25H, T27H, T30H, T40H, Φ2, Φ6×25.4mm | | | |
| Accessory | Magnetic Screw Holder Bit belt holder | | | |

TORX® is a registered trademark of Acument TM Intellectual Properties, LLC (USA). VESSEL has a manufacturing license in Japan and selling same to the world.

HAND TOOLS
 BITS & SOCKETS
 ELECTRIC TOOLS
 AIR TOOLS
 STATIC SOLUTIONS
 GASOLINE ENGINE TOOLS

No. TD-BS Replacement Bit Set



No. TD-BS1  **No. TD-BS2**  **No. TD-BS3** 





Applicable models
TD-70/TD-71/TD-72/TD-73MC/TD-80/TD-150/TD-160/S-12/S-13
TX-10/TX-11/TX-12MC/830MG-4/840/840L

Applicable models
TD-70/TD-71/TD-72
TD-170
TX-11/TD-73MC
TX-12MC

No. TD-BS4 

Cr-V Mo steel Bit

Cr-V steel Socket

| Model No. | Set content | Package size (mm) | Inner Ctn. | EDP No. |
|-----------|---|-------------------|------------|---------|
| TD-BS1 | ⊕1, ⊕2, ⊕3, ⊖4, ⊖6 ×25.4mm Bit belt holder | 120×45×23 | 10 | 251300 |
| TD-BS2 | H 2.5, 3, 4, 5, 6 ×25.4mm Bit belt holder | 120×45×23 | 10 | 251301 |
| TD-BS3 | T10H, T15H, T20H, T25H, T30H ×25.4mm Bit belt holder | 120×45×23 | 10 | 251302 |
| TD-BS4 | A/F 5.5, 7, 8, 10 Socket holder | 120×45×23 | 10 | 251303 |

TORX® is a registered trademark of Acument TM Intellectual Properties, LLC (USA). VESSEL has a manufacturing license in Japan and selling same to the world.

No. TD-64 "PETADORA" Z-shaped Offset Screwdriver



- S-shaped type good for strong tightening in cramped spaces.
- Special plating to keep precision at the tip.

No. TD-64

| | ⊕2/⊖6 | ⊕1/⊕2 |
|------------|------------------------|--------------------------|
| Tip (mm) | 6 0.9 / ⊕No.2 18 6 129 | ⊕No.1 / ⊕No.2 16.5 5 126 |
| Inner Ctn. | 10 | 10 |
| Outer Ctn. | 100 | 100 |
| EDP No. | 250122 | 250121 |

Package size...160×35×12mm

No. 25 Offset Screwdriver



- S-shaped type good for strong tightening in cramped spaces.
- Different size tips combined.

Can be chosen according to applications.

No. 25

| | ⊕1/⊖5 | ⊕2/⊖6 | ⊕3/⊖8 |
|------------|----------|----------|----------|
| Tip (mm) | 25 5 125 | 26 6 125 | 33 8 150 |
| Inner Ctn. | 12 | 12 | 12 |
| EDP No. | 143005 | 143006 | 143007 |

Package size...160×35×12mm

No. 251526 2-Piece Offset Screwdriver Set

| Model No. | Set content | Package size (mm) | Inner Ctn. | EDP No. |
|-----------|--------------------|-------------------|------------|---------|
| 251526 | No.25 ⊖6/⊕2, ⊖5/⊕1 | 210×70×10 | 20 | 243011 |

No. TD-61 "PETADORA" L-shaped Offset Screwdriver



- Special plating to keep precision at the tip.
- L-shaped type good for working in cramped spaces.

No. TD-61

| | ⊖6 | ⊕1 | ⊕2 |
|--------------------|----------------|------------------|----------------|
| Tip (mm) | 6 0.9 18 6 117 | ⊕No.1 16.5 5 105 | ⊕No.2 18 6 117 |
| Cushion Grip color | Blue | Green | Red |
| Inner Ctn. | 10 | 10 | 10 |
| Outer Ctn. | 100 | 100 | 100 |
| EDP No. | 250105 | 250101 | 250102 |

Package size...160×35×14mm

No. TD-63 "PETADORA" L-shaped Offset Screwdriver



- Special plating to keep precision at the tip.
- L-shaped type good for working in cramped spaces.

No. TD-63

| | H 2.5 | H 3 | H 4 | H 5 |
|--------------------|----------------|--------------|--------------|------------|
| Tip (mm) | 2.5 16.5 5 105 | 3 16.5 5 105 | 4 16.5 5 105 | 5 18 6 117 |
| Cushion Grip color | Orange | Purple | Black | Blue |
| Inner Ctn. | 10 | 10 | 10 | 10 |
| Outer Ctn. | 100 | 100 | 100 | 100 |
| EDP No. | 250112 | 250113 | 250114 | 250115 |

Package size...160×35×14mm

One point

Speedy fast-turning,
firm tightening

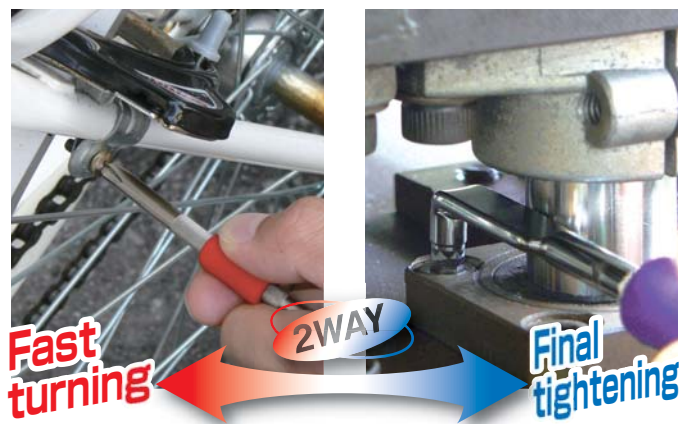

*This one product can be used
from fast-turning to tightening!*

An evolution of offset screwdriver with all the required functions for tightening screws.

No. 83L LED Voltage Detection Screwdriver

- For conduction/ continuity test in general household.
- Long-life LED lights brightly. Batteries can be replaced.
- Handy pencil-type screwdriver.



| Voltage detection range | 4.0 | 0.45 | 20 | 17.5 | 130 | Package size (mm) | Inner Ctn. | EDP No. |
|-------------------------|-----|------|----|------|-----|-------------------|------------|---------|
| 100 to 250V AC | | | | | | 185×70×16 | 10 | 125106 |

One point

Conductivity check of electrical wiring tools

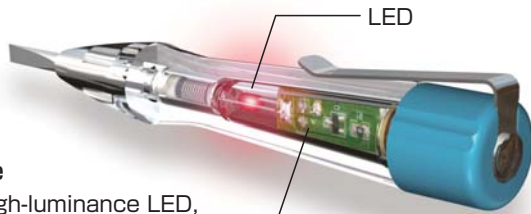

LED type

Uses a high-luminance LED, allowing you to check electrical conductivity easily even in a bright location. Batteries are consumables and need to be replaced.

Conductivity check / polarity discrimination Continuity test



A conductivity check of electrical wiring or receptacle and polarity discrimination of AC hot-line and ground sides



Continuity check of a wiring circuit. Make sure that no power is applied to the circuit before checking continuity.

No. TD-1300L

6-Piece Voltage Detection Screwdriver Set NEW

- Neon tube integrated into the grip end. When contacting the current-carrying point, the neon tube lights and continuity test can be conducted. **Cr-V. steel**
- Resin chuck enables to replace the blades. Lightweight resin grip, with a transparent end-cap at the grip edge.
- Frequently used 6 types of blade in a pack.
- Provided in a handy transparent vinyl carrying and storage pouch.
- Low voltage type (100 to 250V AC)



No. TD-1300L

| Voltage detection range | Reversible blade content (mm) | | | | Inner Ctn. | EDP No. |
|-----------------------------------|-------------------------------|------------------|-----|---------------|------------|---------|
| | ⊖ | ⊕ | Awl | Pin extractor | | |
| 100 to 250V AC | ⊖4×125 ⊖6×125 | ⊕1×125 ⊕2×125 | 125 | 125 | 10 | 247021 |
| Handle length 126.4mm dia. 26.5mm | | | | | | |

※Package size...185×105×31mm

No. TD-1300B

5-Piece Voltage Detection Screwdriver Set NEW

- Neon tube integrated into the grip end. When contacting the current-carrying point, the neon tube lights and continuity test can be conducted. **Cr-V. steel** Except Socket
- Resin chuck enables to replace the blades. Lightweight resin grip, with a transparent end-cap at the grip edge.
- A small diameter type socket suitable for small screws included in replacement blade set.
- Handy vinyl carrying and storage pouch
- Low voltage type (100 to 250V AC)



No. TD-1300B

| Voltage detection range | Reversible blade content (mm) | | | Inner Ctn. | EDP No. |
|-----------------------------------|-------------------------------|------------------|-------------------------|------------|---------|
| | ⊖ | ⊕ | Socket | | |
| 100 to 250V AC | ⊖4×125 | ⊕1×125 ⊕2×125 | A/F5 ×125 A/F5.5×125 | 10 | 247031 |
| Handle length 126.4mm dia. 26.5mm | | | | | |

※Package size...185×105×31mm

HAND TOOLS

BITS & SOCKETS

ELECTRIC TOOLS

AIR TOOLS

STATIC SOLUTIONS

GASOLINE ENGINE TOOLS

No. 240001 Impact Driver

- One-touch switching of the rotation direction.
- Soft non-slip resin handle, comfortable to grip. Designed for less shock on hands.
- For heavy-duty use.
- If the bit adapter is detached, a 12.7 mm socket can be attached.
- Bit insertion part ●8mm



| Set content | | Package size (mm) | Outer Ctn. | EDP No. |
|-------------|---|-------------------|------------|---------|
| Bits | Φ2×36, Φ2×80, Φ3×36, Φ3×80, Φ4×36, ⊖10×36 | | | |
| Body | length 176mm dia. 37.5mm | 220×73×80 | 5 | 246051 |

No. 250001 Impact Driver

- Effective for very tight fastening and loosening rusted screws.
- Suited for automobile maintenance, and assembly and disassembly of machinery and equipment.
- For heavy-duty use.
- If the bit adapter is detached, a 12.7 mm socket can be attached.
- Bit insertion part ●8mm

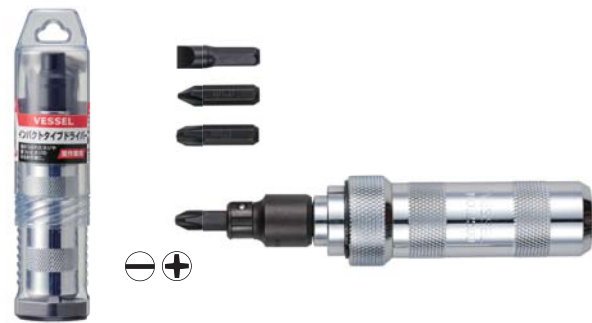

| Set content | | Package size (mm) | Outer Ctn. | EDP No. |
|-------------|------------------------|-------------------|------------|---------|
| Bits | ⊖10, Φ2, Φ3, Φ4×36 | | | |
| Body | length 166mm dia. 32mm | 325×80×38 | 5 | 246001 |

No. 260002 Impact Uni Driver

- Thin handle. Can be used as normal screwdriver.
- Long shank bit. Ideal for hard-to-reach cramped spaces.
- Bit insertion part ●6.35mm



| Set content | | Package size (mm) | Outer Ctn. | EDP No. |
|-------------|----------------------------|-------------------|------------|---------|
| Bits | ⊖5, ⊖6, ⊖7, Φ1, Φ2, Φ3×125 | | | |
| Body | length 132.5mm dia. 26mm | 225×110×33 | 5 | 246016 |

No. C50/C51 Impact Driver Bit

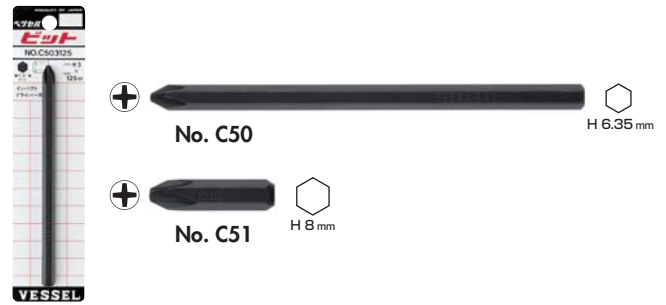

| Model No. | Set content | Applicable models | Package size (mm) | Inner Ctn. | EDP No. |
|-----------|-------------|-------------------|-------------------|------------|---------|
| C502125 | Φ2×125 | 260002 | 170×42 | 10 | 486212 |
| C503125 | Φ3×125 | 260002 | 170×42 | 10 | 486213 |
| C506125 | ⊖6×125 | 260002 | 170×42 | 10 | 486216 |
| C512036 | Φ2×36 | 250001, 240001 | 170×42 | 10 | 486201 |
| C513036 | Φ3×36 | 250001, 240001 | 170×42 | 10 | 486202 |
| C518036 | ⊖8×36 | 250001, 240001 | 170×42 | 10 | 486203 |

»For 10-Piece Set, please refer to page 83.

Mounting quantity: 1

One point

Removal of a rusted or stuck screw

Hitting the handle with a hammer causes the impact to be converted into rotational force.

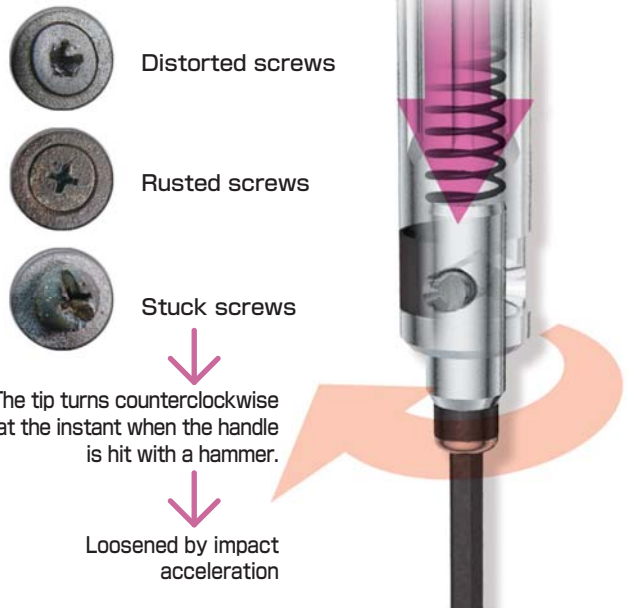

No. TRD-15

Torque Screwdriver

HAND TOOLS

BITS & SOCKETS

ELECTRIC TOOLS

AIR TOOLS

STATIC SOLUTIONS

GASOLINE ENGINE TOOLS



High precision torque screwdrivers with a torque accuracy of $\pm 10\%$ as specified by ISO 6789. Ergonomic & cushion grip friendly to your palm. The hand does not get tired even for long-hour work. For replacement of cemented carbide tips of various machining tools that have been going up in speed. For assembly torque management of precision machines. Also for appropriate tightening of terminal blocks, circuit breakers, or electro-magnetic switches.

Inserting the provided L-shape wrench into the rear of the handle and turning it allows torque setting to be easily accomplished.



No. TRD-15 Torque Screwdriver

Made in Germany, these torque screwdrivers feature our patented double clutch mechanism for outstanding torque precision. High precision torque screwdrivers designed not merely for testing, but for serious, full-scale assembly operations.

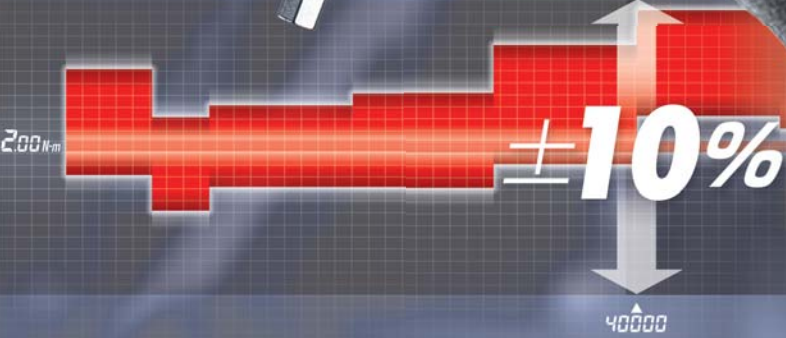

Long life by torque accuracy assurance of 40,000-time repetition

No. TRD-15IP Torque Screwdriver Set

- For TORX PLUS clamp screws used for chip replacement.
- With popular TORX PLUS blades.



| Set content | Torque range (N·m) | Package size (mm) | Outer Ctn. | EDP No. |
|---|--------------------|-------------------|------------|---------|
| TRD-15 Torque Screwdriver (Torque precision ±10%), 6IP, 7IP, 8IP, 9IP, L wrench (A/F 6mm) | 0.6~1.5 | 215×40×40 | 10 | 173011 |

No. TRD-15TX Torque Screwdriver Set

- For TORX clamp screws most often used for chip replacement.
- With popular TORX blades.
- Also suitable for tightening quality of hard disks.



| Set content | Torque range (N·m) | Package size (mm) | Outer Ctn. | EDP No. |
|---|--------------------|-------------------|------------|---------|
| TRD-15 Torque Screwdriver (Torque precision ±10%), T6, T7, T8, L wrench (A/F 6mm) | 0.6~1.5 | 215×40×40 | 10 | 173012 |

TORX® is a registered trademark of Acument TM Intellectual Properties, LLC (USA). VESSEL has a manufacturing license in Japan and selling same to the world.

No. TRD-15 Torque Screwdriver Handle

- Can be used with the dedicated replaceable blades.
- HEX key wrench (A/F 6mm) is included.

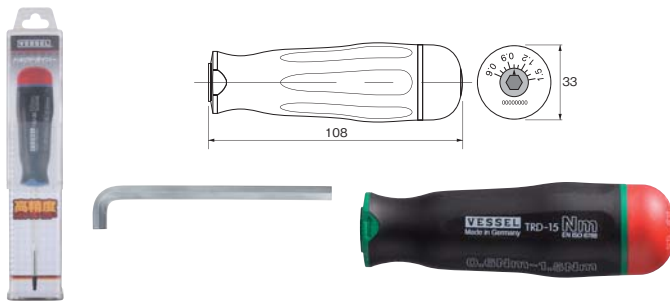

| Model No. | Torque range (N·m) | 1 scale (N·m) | Torque precision (%) | Package size (mm) | Outer Ctn. | EDP No. |
|-----------|--------------------|---------------|----------------------|-------------------|------------|---------|
| TRD-15 | 0.6~1.5 | 0.1 | ±10 | 215×40×40 | 10 | 173001 |

No. BTX Blades for Torque Screwdrivers

- Blades for TORX screws.
- Adopted for replacement of chips of machine tools that has been going up in speed.

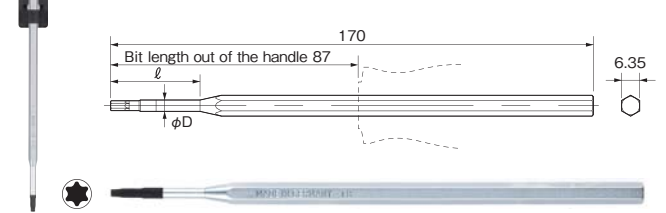

| Model No. | Tip | Tip (mm) | ℓ (mm) | φD (mm) | Outer Ctn. | EDP No. |
|-----------|-----|----------|--------|---------|------------|---------|
| BTX06 | T6 | 1.69 | 30 | 3.5 | 10 | 173206 |
| BTX07 | T7 | 1.97 | 30 | 3.5 | 10 | 173207 |
| BTX08 | T8 | 2.3 | 30 | 3.5 | 10 | 173208 |
| BTX10 | T10 | 2.72 | 30 | 3.5 | 10 | 173210 |
| BTX15 | T15 | 3.26 | 32 | 4.5 | 10 | 173215 |
| BTX20 | T20 | 3.84 | 34 | 5 | 10 | 173220 |

No. B IP Blades for Torque Screwdrivers

- Blades for TORX PLUS screws.
- Adopted for replacement of chips of machine tools that has been going up in speed.



| Model No. | Tip | Tip (mm) | ℓ (mm) | φD (mm) | Outer Ctn. | EDP No. |
|-----------|------|----------|--------|---------|------------|---------|
| B06IP | 6IP | 1.69 | 30 | 3.5 | 10 | 173106 |
| B07IP | 7IP | 1.97 | 30 | 3.5 | 10 | 173107 |
| B08IP | 8IP | 2.29 | 30 | 3.5 | 10 | 173108 |
| B09IP | 9IP | 2.48 | 30 | 3.5 | 10 | 173109 |
| B10IP | 10IP | 2.72 | 30 | 3.5 | 10 | 173110 |
| B15IP | 15IP | 3.25 | 30 | 4.5 | 10 | 173111 |

No. BPH Blades for Torque Screwdrivers

- Blades for Phillips screws.
- Optimal for tightening control of various terminal blocks.



| Model No. | Tip | ℓ (mm) | φD (mm) | Outer Ctn. | EDP No. |
|-----------|-----|--------|---------|------------|---------|
| BPH01 | ⊕1 | 35 | 5 | 10 | 173301 |
| BPH02 | ⊕2 | 35 | 6 | 10 | 173302 |
| BPH03 | ⊕3 | — | — | 10 | 173303 |

No. BHX Blades for Torque Screwdrivers

- Blades for hexagonal socket head bolts and set screw.
- Optimum for assembly of machines or automatic equipment.



| Model No. | Tip | Tip (mm) | ℓ (mm) | φD (mm) | Outer Ctn. | EDP No. |
|-----------|------|----------|--------|---------|------------|---------|
| BHX15 | H1.5 | 1.5 | 29.5 | 3 | 10 | 173321 |
| BHX20 | H2 | 2 | 29.5 | 3 | 10 | 173322 |
| BHX25 | H2.5 | 2.5 | 29.5 | 3 | 10 | 173323 |
| BHX30 | H3 | 3 | 32 | 4 | 10 | 173324 |
| BHX40 | H4 | 4 | 34 | 5 | 10 | 173325 |
| BHX50 | H5 | 5 | 36 | 6 | 10 | 173326 |

No. 8909BP

"RAINBALL" L-wrenches



Easy to spot inside the toolbox. Color-coded by size. Provided with a portable holder to carry around easily. Can be used by fixing onto level metal parts of machine tools, automated machinery, surface plates, etc.



HAND TOOLS

BITS & SOCKETS

ELECTRIC TOOLS

AIR TOOLS

STATIC SOLUTIONS

GASOLINE ENGINE TOOLS



No. 8909BP

"RAINBALL" L-wrenches 9PC SET

Inherits the large tilted angle, which is the greatest characteristic of the RAINBALL. Driving part is set so that it contacts near the entry point of hexagonal hole. Maximum tilted angle is approximately 38°. Moreover, it fits firmly to low head screws such as a button screw.

Provided with a magnetizer

You can directly magnetize and demagnetize a wrench.

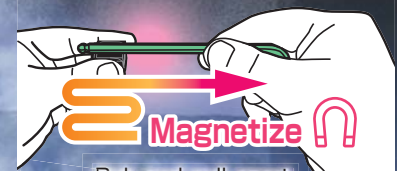

Rub and pull apart.



Even stronger when mounted on wrenches!

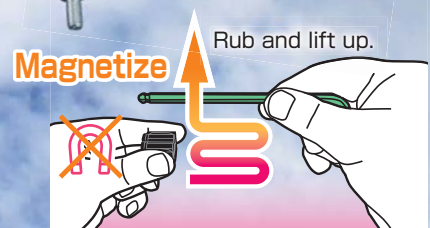

Rub and lift up.

No. 8900BP "RAINBALL" L-wrenches NEW PAT.

- Easy to find in a toolbox. Color-coded by size. Coating is peel-proofed by manganese phosphate under coating.
- New ball shape. Set the driving part so that it contacts near the entry point of the hexagonal hole, with the maximum tilted angle of 38° (design value in our company). The cross-sectional area of the neck of the ball is enlarged to improve the strength.
- High precision black point tip, unaffected by metal plating.
- Cross-section is "Ultra-Hex", which has the 3-point and 3-surface contact geometry to reduce deforming of screw holes.



| No.8900BP | Set content | Package size (mm) | Inner Ctn. | EDP No. |
|-----------|-------------|-------------------|------------|---------|
| H 1.5 | 1.5 15 69 | 160×45×5 | 10 | 144341 |
| H 2 | 2 17.5 74 | 160×45×5 | 10 | 144342 |
| H 2.5 | 2.5 20 83.5 | 160×45×5 | 10 | 144343 |
| H 3 | 3 22 93.5 | 160×45×5 | 10 | 144344 |
| H 4 | 4 28 102.5 | 200×60×8 | 10 | 144345 |
| H 5 | 5 32 123.5 | 200×60×8 | 10 | 144346 |
| H 6 | 6 37 144 | 200×60×8 | 10 | 144347 |
| H 8 | 8 43 166 | 235×75×14 | 5 | 144348 |
| H 10 | 10 49 188.5 | 235×75×14 | 5 | 144349 |

※Colors inside the table cells indicate the body color.

No. 8409BP "ULTRABALL" L-wrenches 9PC Set NEW PAT.

- New ball shape with the maximum tilted angle of 38° (design value in our company). The cross-sectional area of the neck of the ball is enlarged to improve the strength.
- Cross-section is "Ultra-Hex", which has the 3-point and 3-surface contact geometry to reduce deforming of screw holes.
- Provided with a convenient portable holder. This is openable facilitating to pick a necessary size.



| No.8409BP | Set content | Package size (mm) | Inner Ctn. | EDP No. |
|-----------|-------------------------------------|-------------------|------------|---------|
| 8400BP | H 1.5, 2, 2.5, 3, 4, 5, 6, 8, 10 mm | 245×105×27 | 5 | 144353 |
| Accessory | Holder | | | |

No. 8906BP "RAINBALL" L-wrenches 6PC Set NEW PAT.

- Easy to find in a toolbox. Color-coded by size.
- New ball shape with the maximum tilted angle of 38° (design value in our company). The cross-sectional area of the neck of the ball is enlarged to improve the strength.
- Provided with a convenient portable holder.



| No.8906BP | Set content | Package size (mm) | Inner Ctn. | EDP No. |
|-----------|---------------------------|-------------------|------------|---------|
| 8900BP | H 1.5, 2, 2.5, 3, 4, 5 mm | 200×80×13 | 5 | 144352 |
| Accessory | Holder | | | |

No. 8909BP "RAINBALL" L-wrenches 9PC Set NEW PAT.

- Provided with a holder that opens like a fan and utilized as a stand, together with a magnetizer. Can be fixed onto level metal parts of machine tools, automated machinery, surface plates, etc. by the magnetic force of the magnetizer mounted to the lower part of the holder.
- The magnetizer can be taken out from the holder and used to magnetize and demagnetize a wrench.

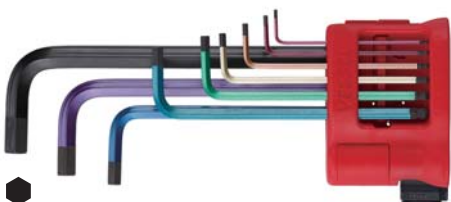

| No.8909BP | Set content | Package size (mm) | Inner Ctn. | EDP No. |
|-----------|-------------------------------------|-------------------|------------|---------|
| 8900BP | H 1.5, 2, 2.5, 3, 4, 5, 6, 8, 10 mm | 245×110×35 | 5 | 144351 |
| Accessory | Magnetizer/Holder | | | |

One point

No.8409BP Ultra Ball

Unique ball configuration allowing the tip to incline 38° maximum facilitates tightening or loosening of screws!

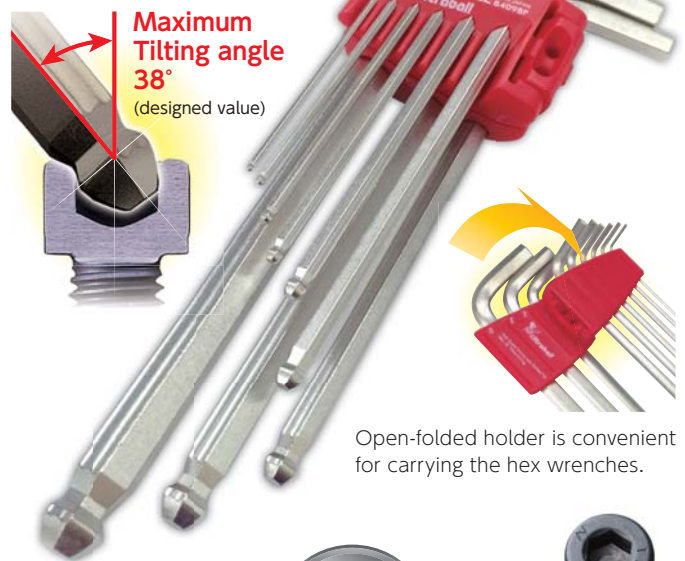

Ultra Hex

Highly durable but no damage on screw surface! 3-point and 3-face contact hexagonal shape maximizes fastening effectiveness.



Surface Contact



No. 8500TX TORX Key Wrench

- Special plating to keep precision at the tip.
- Knurled shank for fast turning.
- Precision tips based on TORX spec.



| No.8500TX | I | | | | Package size (mm) | Inner Ctn. | EDP No. |
|-----------|------|-----|----|-----|-------------------|------------|---------|
| T6 | 1.68 | 2.5 | 15 | 52 | 110×45×5 | 10 | 144301 |
| T7 | 1.97 | 2.5 | 15 | 56 | 110×45×5 | 10 | 144302 |
| T8 | 2.3 | 3 | 17 | 59 | 110×45×5 | 10 | 144303 |
| T9 | 2.48 | 3 | 17 | 63 | 110×45×5 | 10 | 144304 |
| T10 | 2.72 | 3 | 17 | 67 | 110×45×5 | 10 | 144305 |
| T15 | 3.26 | 3.5 | 19 | 72 | 110×45×5 | 10 | 144306 |
| T20 | 3.84 | 4 | 21 | 77 | 110×45×5 | 10 | 144307 |
| T25 | 4.4 | 5 | 23 | 83 | 145×55×8 | 10 | 144308 |
| T27 | 4.96 | 5 | 23 | 90 | 145×55×8 | 10 | 144309 |
| T30 | 5.49 | 6 | 25 | 98 | 145×55×8 | 10 | 144310 |
| T40 | 6.6 | 7 | 27 | 107 | 145×55×8 | 10 | 144311 |

No. 8507TX TORX 7-Piece Key Set

- Special plating to keep precision at the tip.
- Knurled shank for fast turning.
- Precision tips based on TORX spec.



| Set content | | Package size (mm) | Inner Ctn. | EDP No. |
|-------------|-----------------------------------|-------------------|------------|---------|
| 8500TX | T10, T15, T20, T25, T27, T30, T40 | 135×65×17 | 10 | 144315 |
| Accessory | Vinyl package | | | |

No. TX-10 TORX Screwdriver Set

- Provided with bits in a holder.
- Also good for tamper-proof screws.
- New type of bit holder that assuredly holds bits.
- Bit insertion part ϕ 6.35mm
- Cellulose acetate resin grip. Ergonomic design.



| Set content | | Package size (mm) | Outer Ctn. | EDP No. |
|-------------|--|-------------------|------------|---------|
| Body | length 204mm dia. 31.8mm | 235×100×31 | 10 | 252020 |
| Bits | T10H, T15H, T20H, T25H, T27H, T30H, T40H, \oplus 2, \oplus 3, \ominus 6×25.4mm | | | |
| Accessories | Bit belt holder | | | |

TORX® is a registered trademark of Acument TM Intellectual Properties, LLC (USA). VESSEL has a manufacturing license in Japan and selling same to the world.

No. 5400TX Power Grip TORX Screwdriver

- Champagne gold plating keeping the precise tip quality.
- Cellulose acetate resin grip. Ergonomic design.
- For working with tamper-proof screws (T5 and T6 excluded).



| No.5400TX | I | | | | Inner Ctn. | Outer Ctn. | EDP No. | |
|-----------|------|-----|-----|------|------------|------------|---------|--------|
| T 5 × 80 | 1.42 | 80 | 2.5 | 17.0 | 155 | 12 | 60 | 122854 |
| T 6 × 80 | 1.69 | 80 | 2.5 | 17.0 | 155 | 12 | 60 | 122855 |
| T 7H× 80 | 1.97 | 80 | 2.5 | 17.0 | 155 | 12 | 60 | 122856 |
| T 8H× 80 | 2.3 | 80 | 3.0 | 17.0 | 155 | 12 | 60 | 122857 |
| T 9H× 80 | 2.48 | 80 | 3.0 | 17.0 | 155 | 12 | 60 | 122858 |
| T10H× 80 | 2.72 | 80 | 3.0 | 17.0 | 155 | 12 | 60 | 122859 |
| T15H× 80 | 3.26 | 80 | 3.5 | 28.0 | 177 | 6 | 60 | 122860 |
| T20H× 120 | 3.84 | 120 | 4.0 | 28.0 | 217 | 6 | 60 | 122861 |
| T25H× 120 | 4.4 | 120 | 5.0 | 31.8 | 224 | 6 | 60 | 122862 |
| T27H× 120 | 4.96 | 120 | 5.0 | 31.8 | 224 | 6 | 60 | 122863 |
| T30H× 120 | 5.49 | 120 | 6.0 | 35.6 | 235 | 6 | 60 | 122864 |
| T40H× 120 | 6.6 | 120 | 7.0 | 35.6 | 235 | 6 | 60 | 122865 |

TORX® is a registered trademark of Acument TM Intellectual Properties, LLC (USA). VESSEL has a manufacturing license in Japan and selling same to the world.

HAND TOOLS
BITS & SOCKETS
ELECTRIC TOOLS
AIR TOOLS
STATIC SOLUTIONS
GASOLINE ENGINE TOOLS

No. Q6E TORX "E" Socket (SQ9.5mm)

- Work socket (Cannot be used with power tools.)
- Has the 9.5 mm square hole, optimal for automobile maintenance and repair.

Cr-V Mo Steel
Shank only

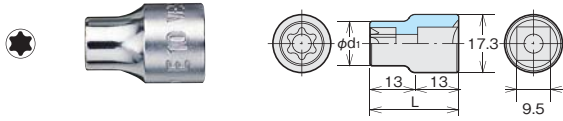

| Model No. | TORX No. | | $\phi d1$ | L (mm) | Inner Ctn. | EDP No. |
|-----------|----------|-------|-----------|--------|------------|---------|
| Q6E8 | E8 | 7.47 | 9.9 | 26 | 10 | 621151 |
| Q6E10 | E10 | 9.37 | 12.0 | 26 | 10 | 621152 |
| Q6E12 | E12 | 11.12 | 14.5 | 26 | 10 | 621153 |

No. Q4T TORX T-type Socket (SQ 6.35mm)

- Work socket (Cannot be used with power tools.) Tamper proof torx.
- Has the 6.35 mm square hole, optimal for automobile maintenance and repair.

Cr-V Mo Steel
Shank only

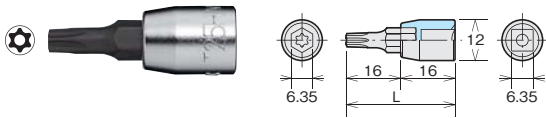

| Model No. | TORX No. | | L (mm) | Inner Ctn. | EDP No. |
|-----------|----------|------|--------|------------|---------|
| Q4T10H | T10H | 2.72 | 32 | 10 | 621131 |
| Q4T15H | T15H | 3.26 | 32 | 10 | 621132 |
| Q4T27H | T27H | 4.96 | 32 | 10 | 621135 |

No. Q6T TORX T-type Socket (SQ 9.5mm)

- Work socket (Cannot be used with power tools.)
- Has the 9.5 mm square hole, optimal for automobile maintenance and repair.

Cr-V Mo Steel
Shank only

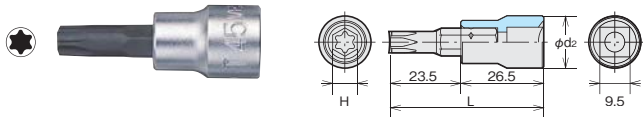

| Model No. | TORX No. | | $\phi d2$ | H | L (mm) | Inner Ctn. | EDP No. |
|-----------|----------|------|-----------|------|--------|------------|---------|
| Q6T30 | T30 | 5.49 | 18 | 6.35 | 50 | 10 | 621136 |
| Q6T45 | T45 | 7.77 | 18 | 8 | 50 | 10 | 621138 |
| Q6T50 | T50 | 8.79 | 20 | 10 | 50 | 10 | 621139 |

No. 944TX 4-Piece MEGADORA FOD TORX Screwdriver Set

PAT.

- Used for work in automobile maintenance field
- Provided with a two-layer structured tray that prevents a screwdriver from being left.

eco Cr-V Steel



| Set content | | Tray size (mm) | Inner Ctn. | Outer Ctn. | EDP No. |
|-------------|--|----------------|------------|------------|---------|
| No.940TX | T20HX120,T25HX120 T30HX120,T40HX120 | 280x135x35 | 1 | 20 | 125804 |

TORX® is a registered trademark of Acument™ Intellectual Properties, LLC (USA). VESSEL has a manufacturing license in Japan and selling same to the world.

One point

Features of TORX tool



Basic TORX consists of 6 ear-lobular shaped curves. Compared to hexagonal shape driver, TORX has higher drive effectiveness and transfers torque smoothly and accurately while eliminating "CAM-OUT".

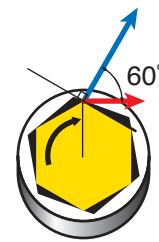
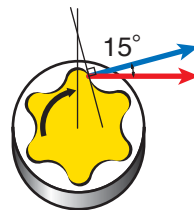

Drive Torque
Loaded Torque

TORX

TORX transfers max torque due to small driving angle.

Hex

Meanwhile, Hex square drive need max upload torque to transfer for large driving angle to other directions.

TAMPER-PROOF TORX SYSTEM



Added function of "Never Touch Screw" a post in the middle of the recess for maximum security eliminates regular TORX drive or any other flat screwdrivers for safety. Tamper proof screws are mostly used at communication equipment and computers so as not to abuse the screwing/unscrewing due to its design and control of function. Keep off unscrewing unless otherwise maintenance serving practiced.

TORX® is a registered trademark of Acument™ Intellectual Properties, LLC (USA). VESSEL has a manufacturing license in Japan and selling same to the world.

No. TX-12MC Plate Ratchet/Magnetic Screw Catcher (TORX)

- Magnet catches a screw firmly.
- Also provided with Torx bits popular in the maintenance. Also used for tamper-proof torx screws.
- The speed ring enables you to turn a screw quickly. Removing the speed ring turn the product a 6.35mm hex drive.
- Bit insertion part ● 6.35mm



| Set content | | Package size (mm) | Inner Ctn. | EDP No. |
|-------------|---|-------------------|------------|---------|
| Body | Plate ratchet screwdriver | 190×85×27 | 10 | 252022 |
| Bits | T8H, T10H, T15H, T20H, T25H, T27H, T30H, T40H, $\Phi 2$, $\Phi 6 \times 25.4$ mm | | | |
| Accessory | Magnetic Screw Holder Bit belt holder | | | |

No. TX-11 TORX Plate Ratchet and Bit Set

- Storage holder included. For working with tamper-proof screws.
- The speed ring enables you to turn a screw quickly.
- Thin ratchet handle for working in cramped places. Ball locking system.
- Can be used with 6.35 mm across flats short bits and 6.35 mm square hole sockets.



| Set content | | Package size (mm) | Inner Ctn. | EDP No. |
|-------------|---|-------------------|------------|---------|
| Body | Plate ratchet screwdriver | 190×85×27 | 10 | 252021 |
| Bits | T8H, T10H, T15H, T20H, T25H, T27H, T30H, T40H, $\Phi 2$, $\Phi 6 \times 25.4$ mm | | | |
| Accessory | Magnetic Screw Holder Bit belt holder | | | |

No. B-340TX Wood-Compo TORX Screwdriver NEW

- Extraordinary non-slip grip; Secures working efficiency even with oily hands.
- Wood-composite resin, reproducing the natural material texture.
- Non-electrolytic plating, keeping the precise tip quality.
- Also good for tamper-proof TORX screws.



| No. | T | H | Length (mm) | Inner Ctn. | Outer Ctn. | JAN (4907587) |
|------|------|-----|-------------|------------|------------|---------------|
| T10H | 2.72 | 80 | 5.5 30 | 188 | 6 120 | 120081 |
| T15H | 3.26 | 80 | 5.5 30 | 188 | 6 120 | 120082 |
| T20H | 3.84 | 120 | 5.5 30 | 228 | 6 120 | 120083 |
| T25H | 4.40 | 120 | 6.4 32 | 236 | 6 60 | 120084 |
| T27H | 4.96 | 120 | 6.4 32 | 236 | 6 60 | 120085 |
| T30H | 5.49 | 120 | 8.0 35 | 246 | 6 60 | 120086 |
| T40H | 6.60 | 120 | 8.0 35 | 246 | 6 60 | 120087 |

No. B-640TX Cushion Grip TORX Screwdriver NEW

- Optimal for fastening screws in precision fields.
- Non-electrolytic plating, keeping the precise tip quality.
- Cushion grip fitting comfortably in a hand.
- Also good for tamper-proof TORX screws (except T5 and T6).



| No. | T | H | Length (mm) | Inner Ctn. | Outer Ctn. | EDP No. |
|-----|------|----|-------------|------------|------------|---------|
| T5 | 1.42 | 40 | 4.0 20.5 | 126 | 6 60 | 123561 |
| T6 | 1.69 | 40 | 4.0 20.5 | 126 | 6 60 | 123562 |
| T7H | 1.97 | 40 | 4.0 20.5 | 126 | 6 60 | 123563 |
| T8H | 2.30 | 40 | 4.0 20.5 | 126 | 6 60 | 123564 |
| T9H | 2.48 | 40 | 4.0 20.5 | 126 | 6 60 | 123565 |

No. TD-6310TX TORX Screwdriver Set NEW

- Bit insertion part ● 6.35mm. Magnetized.
- Holds securely short bits. Reliable fastening as the bit does not drop easily.
- Grip made of environmental-friendly plant material.
- Provided with a bit belt for storage.



| Set content | | Package size (mm) | Outer Ctn. | EDP No. |
|-------------|---|-------------------|------------|---------|
| Body | length 213mm dia. 28.5mm | 235×100×29 | 10 | 247028 |
| Bits | $\Phi 6$, $\Phi 2$, T8H, T10H, T15H, T20H, T25H, T27H, T30H, T40H ×25.4mm | | | |
| Accessories | Bit belt holder | | | |

TORX® is a registered trademark of Acument TM Intellectual Properties, LLC (USA). VESSEL has a manufacturing license in Japan and selling same to the world.

HAND TOOLS

BITS & SOCKETS



ELECTRIC TOOLS

AIR TOOLS

STATIC SOLUTIONS







GASOLINE ENGINE TOOLS

No. 990TX G-grip TORX Screwdriver PAT.



- The weight of the steel ball keeps the end cap in an optimum position for a grip.   
- A special precision spring is welded to the tip by laser, enabling the screwdriver to catch a TORX screw firmly by spring action.



No.990TX

| | Inner (mm) | Outer (mm) | Inner Ctn. | Outer Ctn. | EDP No. | | | |
|--|------------|------------|------------|------------|---------|----|-----|--------|
| T3 × 40 | 1.13 | 40 | 2.5 | 16 | 21 138 | 12 | 240 | 125921 |
| T5 × 40 | 1.42 | 40 | 2.5 | 16 | 21 138 | 12 | 240 | 125923 |
|  T6 × 40 | 1.69 | 40 | 2.5 | 16 | 21 138 | 12 | 240 | 125924 |
|  T8 × 40 | 2.3 | 40 | 2.5 | 16 | 21 138 | 12 | 240 | 125926 |
|  T9 × 40 | 2.48 | 40 | 4.0 | 16 | 21 138 | 12 | 240 | 125927 |
|  T10×80 | 2.72 | 80 | 4.0 | 30 | 38 195 | 6 | 60 | 125928 |
|  T15×80 | 3.26 | 80 | 5.5 | 30 | 38 195 | 6 | 60 | 125929 |
|  T20×80 | 3.84 | 80 | 5.5 | 30 | 38 195 | 6 | 60 | 125930 |

No. TD-6816MG Ratchet Screwdriver (16-pc bit set) NEW



- Smoothly click feeling realized by rotating angle of 5° and 72 gears. High strength accomplished by 2 nails supporting the ratchet gear. It can be used for final tightening work.   
- The handle is made out of oil-resistance cellulose acetate resin.
- Easy to carry around with cassette type bit storage inside the handle.
- 16 types of bits to adapt to various types of work. Magnetic bits can be replaced with one-touch.
- Bit insertion part ●6.35mm.

Set content

| | |
|------|--|
| Body | length 177mm dia. 28.5mm |
| Bits | ⊕1, ⊕2, ⊕3, ⊖6, H2, H2.5, H3, H4, H5, T10H, T15H, T20H, T25H, T27H, T30H, T40H ×25.4mm |

| | | | |
|-------------------|------------|------------|---------|
| Package size (mm) | Inner Ctn. | Outer Ctn. | EDP No. |
| 235×90×29 | 5 | 30 | 247025 |

No. TD-6808TX Ratchet Screwdriver TORX (8-pc bit set) NEW

- Smoothly click feeling realized by rotating angle of 5° and 72 gears. High strength accomplished by 2 nails supporting the ratchet gear. It can be used for final tightening work.   
- The handle is made out of oil-resistance cellulose acetate resin.
- Easy to carry around with cassette type bit storage inside the handle.
- Stores 8 types of bits including TORX bit. Magnetic bits can be replaced with one-touch.
- Bit insertion part ●6.35mm.

Set content

| | |
|------|--|
| Body | length 177mm dia. 28.5mm |
| Bits | ⊕2, ⊕3, T10H, T15H, T20H, T25H, T30H, T40H ×25.4mm |

| | | | |
|-------------------|------------|------------|---------|
| Package size (mm) | Inner Ctn. | Outer Ctn. | EDP No. |
| 235×80×29 | 5 | 30 | 247024 |

No. TD-BS3 Replacement Bit Set





| Model No. | Set content | Package size (mm) | Inner Ctn. | EDP No. |
|---------------|---|-------------------|------------|---------|
| TD-BS3 | T10H, T15H, T20H, T25H, T30H ×25.4mm Bit belt holder | 120×45×23 | 10 | 251302 |







TORX® is a registered trademark of Acument TM Intellectual Properties, LLC (USA). VESSEL has a manufacturing license in Japan and selling same to the world.

TORX is also available for bits.





Industrial Bits Type A

- No.V TORX Bit P62
- No.V TORX Bit (Tamper-Proof) P63
-   No.V5 TORX Bit P64
-  No.V5 TORX Bit (Tamper-Proof) P64

Industrial Bits Type B

- No.N TORX Bit P67, P78
- No.N TORX Bit (Tamper-Proof) P67, P78
-   No.J TORX Bit P70
-   No.J TORX Bit (Tamper-Proof) P70
-  No.A5 TORX Bit P71
-  No.A5 TORX Bit (Tamper-Proof) P71

Precision Bits

- No.DS73 Shockless Bit P75
-  No.D71 TORX Bit P76
-  No.D73 TORX Bit P76
-  No.D76 TORX Bit P77
-  No.D76 TORX Bit (Tamper-Proof) P77

Short Bits

- No.A4 TORX Bit P82
-  No.A4 TORX Bit (Tamper-Proof) P82

Construction Bits

- No.SMVT TORX Bit (Tamper-Proof) P95
-  No.SMVT TORX Bit (Tamper-Proof) P95

"PROKON" series

- No.SS16T Recessed "SAKISUBO" TORX Bit P111
-  No.SS16T Recessed "SAKISUBO" TORX Bit P111

TORX® is a registered trademark of Acument TM Intellectual Properties, LLC (USA). VESSEL has a manufacturing license in Japan and selling same to the world.

No. 3200VA-1

VA cable stripper



The 3200VA-1 is a solution for stripping strenuous cables such as VA cables which becomes soft and elongates during the summer or as eco-friendly PE cables, which hardness during winter months.



HAND TOOLS

BITS & SOCKETS

ELECTRIC TOOLS

AIR TOOLS

STATIC SOLUTIONS

GASOLINE ENGINE TOOLS



No. 3200VA-1

VA cable stripper

The depth of cut by blades can be adjusted by 5 levels to support the different hardness of coating for different wire manufacturers. Designed to hold the wire coating so that the core line is always at the center, to prevent jamming.

No. 3200VA-1 VA cable stripper

PAT.

- Even for eco-friendly PE cables, clear stripping can be perfectly achieved with light force. 
- Corresponds to various sheath hardness according to cable manufacturers. Can adjust cutting depth in 5 steps.
- Precision blades by the metal injection offer excellent cutting quality.
- Designed to hold wire sheath so that the core conductor is always located at the center, preventing the blades from cutting into the conductor.



← See P48



| Model No. | Overall length (mm) | Weight (g) | Wire size | Outer Ctn. | EDP No. |
|-----------|---------------------|------------|---|------------|---------|
| 3200VA-1 | 180 | 370 | PVC cables (VVf/ VA cables) PE cables (EM-EEF/ Eco cables) φ1.6mm duplex/φ2.0mm duplex φ1.6mm triplex/φ2.0mm triplex | 5 | 141016 |

Package size...250×115×63mm



No. WB-013 For 3200VA-1 Replacement Blade

| Model No. | Applicable wire stripper | Package size (mm) | Inner Ctn. | EDP No. |
|-----------|--------------------------|-------------------|------------|---------|
| WB-013 | 3200VA-1 | 120×45×3 | 10 | 141084 |

No. 3500E-1/-2 Wire Stripper



- Lightweight (100g), compact handy type. 
- Diamond finely polished blade for precision stripping.
- AWG-mm-mil conversion table on the grip.



| Model No. | Overall length (mm) | Weight (g) | Color | Inner Ctn. | Outer Ctn. | EDP No. |
|-----------|---------------------|------------|--------|------------|------------|---------|
| 3500E-1 | 155 | 100 | Red | 5 | 30 | 141036 |
| 3500E-2 | 155 | 100 | Yellow | 5 | 30 | 141037 |

Package size...220×75×13mm

| 3500E-1 | AWG | 12 | 14 | 16 | 18 | 20 | 22 | 24 |
|--------------------|-----------------|-----|-----|------|------|------|------|------|
| | Solid wire (mm) | 2.0 | 1.6 | 1.3 | 1.0 | 0.8 | 0.65 | 0.5 |
| Standard wire (mm) | 3.3 | 2.0 | 1.3 | 0.8 | 0.5 | 0.3 | 0.2 | |
| 3500E-2 | AWG | 18 | 20 | 22 | 24 | 26 | 28 | 30 |
| | Solid wire (mm) | 1.0 | 0.8 | 0.65 | 0.5 | 0.4 | 0.3 | 0.25 |
| Standard wire (mm) | 0.8 | 0.5 | 0.3 | 0.2 | 0.13 | 0.08 | 0.05 | |

No. 3000 Wire Stripper

- Nimble and cleanly strips off sheathing in a single operation. 
- Can be used with wiring for TV, radio, home appliances, electrical work, automotive circuits, telephones, etc.
- With a strip gauge.



| Model No. | Overall length (mm) | Weight (g) | Wire diameter and nominal sectional area | Handle color | Outer Ctn. | EDP No. |
|-----------|---------------------|------------|--|--------------|------------|---------|
| 3000A | 170 | 350 | For solid wire 0.5/1.2/1.6/2.0mm | Green | 20 | 141001 |
| 3000B | 170 | 350 | For solid wire 1.0/1.6/2.0/2.6/3.2mm | Red | 20 | 141002 |
| 3000C | 170 | 350 | For stand wire 0.9/1.25/2.0/3.5/5.5mm | Black | 20 | 141000 |

Package size...220×75×13mm

Wire Stripper Cardbord product

| Model No. | Wire diameter and nominal sectional area | Package size (mm) | Outer Ctn. | EDP No. |
|-----------|--|-------------------|------------|---------|
| 300001 | For solid wire 0.5/1.2/1.6/2.0mm | 250×110×38 | 5 | 241001 |
| 300002 | For solid wire 1.0/1.6/2.0/2.6/3.2mm | 250×110×38 | 5 | 241002 |
| 300005 | For stand wire 0.9/1.25/2.0/3.5/5.5mm | 250×110×38 | 5 | 241005 |

Wire Stripper Blade

| Model No. | Applicable wire stripper | Wire diameter and nominal sectional area | Package size (mm) | Inner Ctn. | EDP No. |
|-----------|--------------------------|--|-------------------|------------|---------|
| WB-001 | 3000 A, 300001 | For solid wire | 95×30×15 | 5 | 141071 |
| WB-002 | 3000 B, 300002 | For solid wire | 95×30×15 | 5 | 141072 |
| WB-003 | 3000 C, 300005 | For stand wire | 95×30×15 | 5 | 141073 |

One point

Features of wire strippers

3200VA-1



Wire strippers dedicated for VA cables and eco-friendly PE cables (VVf/EM-EEF)

For solid wire 1.6mm×2/3duplex/triplex

For solid wire 2.0mm×2/3duplex/triplex

3500E-1/3500E-2



For cutting and stripping of various electronic wires represented by KV

For solid wire 0.25mm~2.0mm
For stand wire 0.05mm~3.3mm

3000



For stripping of various wires and cords including IV and VSF

Solid wires: 0.5mm to 3.2mm
Stranded cables: 0.9mm to 5.5mm

No. DB-200 Bucket for Electricians NEW

- Convenient for collecting wire scraps and carrying tools and instruments.
- Belt length can be adjusted.
- Elliptical shape to fit comfortably.



| Size with header (mm) | Outer Ctn. | EDP No. |
|-----------------------|------------|---------|
| H280 × W200 × D125 | 1 | 141034 |

No. 76-10 Gel Grip Hammer (Plastic Head) NEW

- Gel resin grip drastically absorbs the shocks by hammer blows to your palm. Alleviates the strain on your wrist.
- Slip resistance grip design of elastomer resin.
- Excellent balance between both heads, ensuring firm feeling of hammering.
- Hammer heads are screwed on and replaced easily. Replacement head is available as option.



| Model No. | Size | Length | Head Diameter | Head Length (mm) | Weight (g) | Inner Ctn. | Outer Ctn. | EDP No. |
|--------------|------|--------|---------------|------------------|------------|------------|------------|---------|
| 76-10 | 1 | 315 | 32 | 120 | 430 | 6 | 60 | 142082 |

Replacement Head for No.76 (Plastic Head)

| Model No. | Set content | Package size (mm) | Inner Ctn. | Outer Ctn. | EDP No. |
|-------------------------------|-------------|-------------------|------------|------------|---------|
| 076110 Card Product | 1Lb×2pcs | 170×60×35 | - | 5 | 242024 |
| 76-10H Boxed | 1Lb | 130×155×35 | 20 | 400 | 142131 |

※Apply hammer Gel Grip Hammer No.76-10 No.77-10
Plastic Head Hammer No.70-1



No. 70 Plastic Head Hammer

- Soft durable plastic head. Does not damage workpieces.
- Replacement head is available as option in a box.
- Replacement head of 1/2, 1 and 1 1/2 sizes is also available in 2-pc pre-carded package.



To replace the hammer head

| Size | Length | Head | | Inner Ctn. | Outer Ctn. | EDP No. |
|--------------|--------|----------|-------------|------------|------------|---------|
| | | Diameter | Length (mm) | | | |
| 1/4 | 280 | 19.5 | 66.5 | 6 | 60 | 142001 |
| 1/2 | 280 | 25 | 82 | 6 | 60 | 142002 |
| 1 | 295 | 31.3 | 108 | 6 | 60 | 142003 |
| 1 1/2 | 325 | 37.6 | 125.5 | 6 | 36 | 142004 |
| 2 | 350 | 45.4 | 139 | 6 | 24 | 142005 |

Handles are not separately sold.

Replacement head for No.70

| Model No. | Set content | Package size (mm) | Inner Ctn. | Outer Ctn. | EDP No. |
|----------------------|-------------|-------------------|------------|------------|---------|
| Head 70×1/4 | 1/4 | 85×102×20 | 20 | - | 142011 |
| Head 70×1/2 | 1/2 | 110×132×27 | 20 | 400 | 142012 |
| Head 70×1 | 1 | 130×155×35 | 20 | 400 | 142013 |
| Head 70×1 1/2 | 1 1/2 | 80×185×42 | 10 | 400 | 142014 |
| Head 70×2 | 2 | 100×225×48 | 10 | 400 | 142015 |

Replacement head for No.70 Cardbord Products

| Model No. | Set content | Package size (mm) | Outer Ctn. | EDP No. |
|---------------|-------------|-------------------|------------|---------|
| 070105 | 1/2×2pcs | 170×60×26 | 5 | 242012 |
| 070110 | 1×2pcs | 170×60×35 | 5 | 242013 |
| 070115 | 1 1/2×2pcst | 210×75×41 | 5 | 242014 |



⚠ WARNING concerning Hammers

- Strike target directly. Do not hit at an angle, etc.
- Do not strike anywhere but the target area.

No. 77-10 Gel Grip Hammer (Rubber/Plastic Head)

- Gel resin grip drastically absorbs the shocks by hammer blows to your palm. Alleviates the strain on your wrist.
- Slip resistance grip design of elastomer resin.
- Excellent balance between both heads, ensuring firm feeling of hammering.
- Hammer heads are screwed on and replaced easily. Replacement head is available as option.
- The hammer heads are screwed on and replaced easily. Rubber head is available as option. Rubber head is of light gray color, which does not cause color staining to the object.



| Model No. | Size | Length | Head Diameter | Head Length (mm) | Weight (g) | Inner Ctn. | Outer Ctn. | EDP No. |
|--------------|------|--------|---------------|------------------|------------|------------|------------|---------|
| 77-10 | 1 | 315 | 32 | 120 | 430 | 6 | 60 | 142091 |

Replacement Head for No.77 (Rubber Head)

| Model No. | Set content | Package size (mm) | Inner Ctn. | Outer Ctn. | EDP No. |
|-------------------------------|-------------|-------------------|------------|------------|---------|
| 077110 Card Product | 1Lb×2pcs | 170×60×35 | - | 5 | 242021 |
| 77-10H Boxed | 1Lb | 130×155×35 | 20 | 400 | 142121 |

※Apply hammer Gel Grip Hammer No.77-10
Cannot be used for plastic hammer No.70-1.



One point

GEL resin grip



Built-in gel cushions the shock to the palm

Cushions the shock to the palm of hammering blows. Alleviates the strain on your wrist.

Slip-resistant grip design

By gel, the contact surface with the palm increases. Non-slip grip with projected parts.



HAND TOOLS

BITS & SOCKETS

ELECTRIC TOOLS

AIR TOOLS

STATIC SOLUTIONS

GASOLINE ENGINE TOOLS

No. RG-95 Ratchet Rivet Gun



- Can calk blind rivets easily with one hand.
- Easily calks 4.8 mm steel rivets that were difficult to use with existing manual riveters.



| Set content | | Package size (mm) | Outer Ctn. | EDP No. |
|-------------|---|-------------------|------------|---------|
| Body | overall length 230mm weight 570g | 350×140×30 | 5 | 621310 |
| Accessories | Nose piece 2.4, 3.2, 4.0, 4.8mm Nose piece wrench A/F 10mm | | | |

No. 8 Thread File

- Quickly restores threads of tooling machines, automobiles, etc.
- 1 tool can be used with 8 different thread pitches.

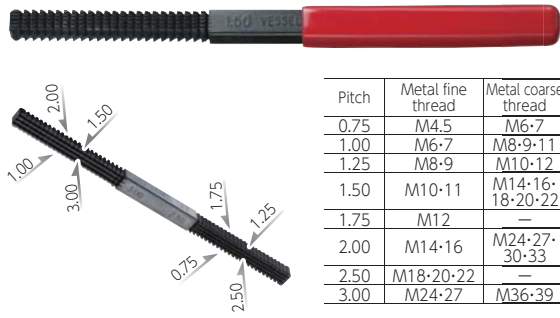

| Pitch | Metal fine thread | Metal coarse thread |
|-------|-------------------|---------------------|
| 0.75 | M4.5 | M6-7 |
| 1.00 | M6-7 | M8-9-11 |
| 1.25 | M8-9 | M10-12 |
| 1.50 | M10-11 | M14-16-18-20-22 |
| 1.75 | M12 | — |
| 2.00 | M14-16 | M24-27-30-33 |
| 2.50 | M18-20-22 | — |
| 3.00 | M24-27 | M36-39 |

| Set content | | Package size (mm) | Outer Ctn. | EDP No. |
|-------------|--|-------------------|------------|---------|
| Pitch (mm) | 0.75 / 1.00 / 1.25 / 1.50 1.75 / 2.00 / 2.50 / 3.00 | 270×75×12 | 10 | 621111 |

No. 5700WP Water Faucet Screwdriver

- Large sized tip enables stable fastening work as it fits well.



| Package size (mm) | | Inner Ctn. | EDP No. | | | | | |
|-------------------|-----|------------|---------|----|-------|-----------|---|--------|
| 18 | 1.6 | 85 | 8 | 30 | 134.5 | 182×40×30 | 6 | 121572 |

No. 5700BD Car Battery Screwdriver

- Special coin-shaped drive tip with A/F 10mm hexagonal opening.
- Handle color changes depending on viewing angle.

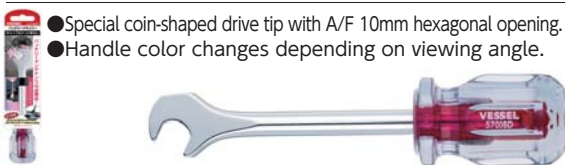

| Package size (mm) | | Inner Ctn. | EDP No. | | | | | | |
|-------------------|----|------------|---------|---|------|-----|-----------|---|--------|
| 18 | 10 | 1.6 | 85 | 8 | 28.5 | 133 | 182×40×30 | 6 | 121571 |

No. ZW-3/ZW-4 Thread Thru Stud Wrench

- Works with continuous thread studs, cut bolts and hanger bolts.
- Can be used 2 ways: Straight for tightening, or bent for fast turning.
- Can be used from halfway point with long hanger bolts.
- Lightweight, compact and easy to carry.



| | Thread part | 32 | 20 | 140 | Weight (mm) (g) | Package size (mm) | Inner Ctn. | EDP No. |
|------|-------------|----|----|-----|-----------------|-------------------|------------|---------|
| ZW-3 | 3/8 | 32 | 20 | 140 | 224 | 195×64×27 | 10 | 621320 |
| ZW-4 | 1/2 | 32 | 20 | 140 | 222 | 195×64×27 | 10 | 621321 |

One point

Features of special tools



Ratchet Rivet Gun
Allows you to caulk blind rivets easily with one hand



Thread File
For restoring of screw threads
One file can be used for eight different thread pitches.



Thread Thru Stud Wrench
Dedicated for installing a full-thread bolt
It can be bent to turn a bolt quickly.



Tap Screwdriver
Used for tightening and loosening of a water shut-off valve, flow-regulating valve, or check valve



Car Battery Screwdriver
It is a combination of a spanner with width across flats of 10mm for car battery removal and a coin-shaped drive tip.